







Plus

Furniture line Plus is all about supporting the efficiency, flexibility, and possibility of unlimited arrangements of work stations, both individual and team. Look at your desk as at a key factor of your success and discover the possibilities that gives you the new line Plus.

Die Möbelkollektion Plus setzt auf Förderung von Effektivität, auf Flexibilität und unbeschränkte Gestaltungsmöglichkeiten von Arbeitsplätzen, sowohl für individuelle als auch für teamfähige Bedürfnisse. Erleben Sie Ihr Büro als ein Schlüsselfaktor für Ihren Erfolg und lassen Sie sich durch die Möglichkeiten der neuen Möbelkollektion Plus bezaubern!

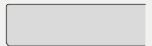
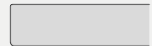

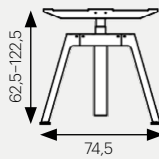



COLLECTION ELEMENTS / ELEMENTE DER KOLLEKTION

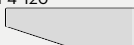

EXECUTIVE DESKS / CHEFZIMMER-SCHREIBTISCHE					
DESKTOP / TISCHPLATTE	version 1 / Variante 1	version 2 / Variante 2	version 3 / Variante 3	version 4 / Variante 4	version 5 / Variante 5
	natural veneer, desktop thickness 25 mm, bottom milled edges, rounded corners. / Naturfurnier, Plattendicke 25mm, Kanten von unten gefräst, Ecken gerundet.	nano-laminate on plywood, desktop thickness 25mm, bottom milled edges, rounded corners. / nano-laminat Sperrholz, Plattendicke 25mm, Kanten von unten gefräst, Ecken gerundet	HPL board on plywood, desktop thickness 25 mm, bottom milled edges, rounded corners. / HPL-Sperrholz, Plattendicke 25mm, Kanten von unten gefräst, Ecken gerundet.	nano-laminate with 1 mm laser edge, desktop thickness 25 mm, straight edges, straight corners / nano-laminat mit einem Rand von 1 mm Stärke, Plattendicke 25 mm, Kanten und Ecken gerade ausgeführt	melamine faced chipboard (MFC), with 2 mm edge, desktop thickness 25 mm, straight edges, straight corners. / Melaminbeschichtete Holzspanplatte, abgeklebt mit einem Rand von 2 mm Stärke, Plattendicke 25 mm, Kanten und Ecken gerade ausgeführt.
					
FRAME	frame under the desktop is made of profiled perforated metal sheet, horizontal cable management / Gestell unter der Tischplatte aus Profil-Lochblech, ausgelegt für horizontale Kabelführung				
	vertical cable management in every leg. / Vertikale Kabelführung in jedem Schreibtischbein.				
	frames of desks with and without electric adjustment look differently / Gestelle für Schreibtische mit/ohne elektrische Höhenverstellung (unterschiedliches Design)				
	a desk with electric height adjustment within the range 65-130 mm, using a driver fixed to a desktop, connection to power is necessary (length of the wire: 3 m), supply 230 V, standard earth continuity plug (PL), spiral cable available as an option for additional charge / Elektrisch höhenverstellbares Schreibtisch von 65-130cm, Verstellung mithilfe von einem an der Tischplatte angebrachten Steuergerät, Einspeisung erforderlich (Kabellänge: 3m), Einspeisung 230V, Standard-Schutzkontaktstecker (PL), Spiralkabel gegen Aufpreis		frame of the executive desk with the height adjustment / Gestell für Chefzimmer-Schreibtisch mit elektrischer Höhenverstellung		
					
	fixed desktop / Feste Tischplatte				
	the desktop in both types of desks is fixed with brackets, distance from the edge of the desktop allows fixing accessories - e.g. rail top unit. / In beiden Tischvarianten ist die Tischplatte auf Konsolen montiert, wobei der Abstand vom Plattenrand die Montage von Accessories, z.B. von einem Schienenaufsatz, ermöglicht.				
	in desks with adjustable height the distance from the short desktop edge is 6.5 cm. / Bei Schreibtischen mit Höhenverstellung beträgt der Abstand von kürzerem Plattenrand 6,5 cm.				
FEET	level adjustment in the range of 10 mm, made of black plastic; on the feet there are metal bases, powder-coated in the colour of the frame. / Nivellierfüße Einstellbereich von 10 mm, aus Schwarzem Kunststoff, mit Metallaufläufen, pulverbeschichtet in der Gestellfarbe.				

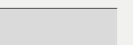
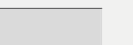
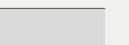
COLLECTION ELEMENTS / ELEMENTE DER KOLLEKTION

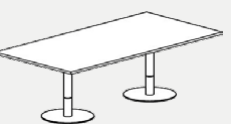
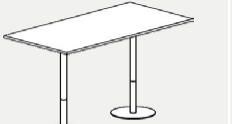
CABINETS / SCHRÄNKE, SIDEBOARDS			
TYPES OF CABINETS / SCHRANK-VARIANTEN	cabinet with drawers and doors, with sliding doors / Schränke mit Schubladen und Flügeltüren/Schiebetüren	upper and hanging cabinets / Aufsatz- und Hängeschränke	containers and CARGO / Containers und CARGO
FRONT / FRONT	melamine board / Melamine Platte	natural veneer / Naturfurnier	MDF with milled dimples of approx. 30 mm diameter, Depth / T 3 mm, lacquered - laquer matt / MDF gefräst – Einfresungen Durchmesser ca. 30 mm, Tiefe 3 mm abgeschrägt, Lackbeschichtung strukturiert
	fronts - both doors and drawers do not have any handles (except for upper cabinet P4-308 with tambour door), between a body and a front there is a recessed anodized aluminium slat functioning as a handrail / Fronte – sowohl Türen als auch Schubladen - sind grifflos (mit Ausnahme von Rollo-Aufsatzschrank P4-308). Zwischen dem Korpus und der Front ist eine nach hinten versetzte Leiste aus eloxiertem Alu angebracht, die als Griff dient.		
BODY / KORPUS	MFC 18 mm with 2 mm edge / melaminbeschichtete Spanplatte 18 mm, abgeklebt mit einem Rand von 2 mm Stärke		
GRAIN / MASSERUNG	bodies have horizontal grains, direction of the front grains as shown in drawing / Korpus sind mit horizontaler oder vertikaler Maserung nach Zeichnung versehen, Maserungsverlauf bei Fronten nach Kundenwunsch		
DRAWERS / SCHUBLADEN	drawers - metal drawer inserts with a blockade preventing from pulling out more than one drawer, with full extraction and soft closing, optional central lock, 2 jack keys / Schubladen – Schubladeneinsätze aus Metall, Auszugssperre, Vollauszug mit Silentschließmechanismus, Zentralschloss optional, 2 Knickschlüssel		
DOOR / INNENAUSSTATTUNG	110-degree hinge door - with soft closing / Türen mit 110°-Scharnieren mit Sanftschließmechanismus		
	sliding door put on the body, sliding system on aluminium rails let into the body, with location blocking, optional lock / Vorliegende Schiebetüren, Schiebetürsystem mit eingelassenen Alulaufschielen, mit Verriegelung, Schloss optional		
BASE / WHEELS SOCKEL / ROLLEN	metal base, powder-coated, levelling in the range 20 mm / height 80 mm / Metallsockel, pulverbeschichtet, Nivellierbereich 20 mm/Höhe 80 mm		
	PLUS wheels white or black, 2 pcs. with a break/2 without a break / Rollen PLUS, Schwarz bzw. Weiß, 2 Stck. mit Feststeller/2 Stck. ohne Feststeller		
	horizontal level adjusting in range of 10 mm / Niveaueausgleich 10mm		
LOCK / SCHLOSS	possibility to assemble a lock for an additional fee / Schlos möglich gegen Aufpreis		

COLLECTION ELEMENTS / ELEMENTE DER KOLLEKTION

TABLES / TISCHE						
TOP / TISCHPLATTEN	Version 1 / Variante 1 natural veneer, desktop thickness 25 mm, bottom milled edges, rounded corners / Naturfurnier, Plattendicke 25 mm, Kanten von unten gefräst, Ecken gerundet, except for tables P4-119 and P4-120 / mit Ausnahme der Tabellen P4-119 und P4-120 	Version 2 / Variante 2 nano-laminate on plywood, desktop thickness 25mm, bottom milled edges, rounded corners. / nano-laminat Sperrholz, Plattendicke 25mm, Kanten von unten gefräst, Ecken gerundet 	Version 3 / Variante 3 HPL board on plywood, desktop thickness 25 mm, bottom milled edges, rounded corners / HPL-Sperrholz, Plattendicke 25 mm, Kanten von unten gefräst, Ecken gerundet 	Version 4 / Variante 4 nano-laminate with 1 mm laser edge, desktop thickness 25 mm, straight edges, straight corners / nano-laminat mit einen Rand von 1 mm Stärke, Plattendicke 25 mm, Kanten und Ecken gerade ausgeführt 	Version 5 / Variante 5 MFC, with 2 mm edge, desktop thickness 25 mm, straight edges, straight corners / Melaminbeschichtete Holzspanplatte, abgeklebt mit einem Rand von 2 mm Stärke, Plattendicke 25 mm, Kanten und Ecken gerade ausgeführt 	Version 6 / Variante 6 MDF lacquered, top thickness 25 mm, 18 mm or 12 mm / MDF Lackbeschichtung strukturiert, Plattendicke 25 mm, 18 bzw. 12 mm 
TYPES OF TABLES / TISCHVARIANTEN:	CONFERENCE TABLES of height 74 cm / KONFERENZTISCHE Höhe 74 cm			HIGH CONFERENCE TABLES of height 110 cm / KONFERENZTISCHE HOCHVARIANTE 110 cm		
FRAME / GESTELL	on legs as in executive desks / Chefzimmer-Schreibtischbeine	on disk legs / Säulentischbein	on disk legs / Säulentischbein			
			with single top / mit Einzeltischplatte	with double top / mit Doppeltischplatte		
						
FRAME OPTIONS / GESTELLVARIANTEN	tables on legs as in desks / Schreibtischbeine	tables on disk base / Säulentischbein				
EXECUTION TECHNOLOGY: / FERTIGUNGS-VARIANTEN:	POWDER-COATED METAL / METALL PULVERBESCHICHTET	under the table top there is a frame with a duct for horizontal cable management / unter der Tischplatte ist Gestell mit Kabelkanal zur horizontalen Kabelführung untergebracht	frame under the top and the upper part of the leg powder-coated metal / Gestell unter der Tischplatte und Oberteil des Säulentischbeins aus Metall, pulverbeschichtet	lower part of the leg and the disk stainless steel or powder-coated/ Unterteil des Säulentischbeins und Bodenplatte aus rostfreiem Stahl oder pulverbeschichtet		
LEGS / BEINE	duct for vertical cable management in every leg / in jedem Bein Kabelkanal zur vertikalen Kabelführung					
FEET / FÜSSE	feet with level adjustment in the range of 20 mm / Nivellierbereich 20 mm plastic, black, covered with a metal cover in the colour of a frame / Kunststoff, Schwarz, mit Metallaufsatz in der Gestellfarbe					

COFFEE TABLES / KAFFEETISCHE			
TOP / TISCHPLATTEN	natural veneer, top thickness 18 mm, top edges straight / Naturfurnier, Plattendicke 18mm, Plattenkanten gerade ausgeführt	nano-laminate on plywood, desktop thickness 25mm, bottom milled edges, rounded corners. / nano-laminat Sperrholz, Plattendicke 25mm, Kanten von unten gefräst, Ecken gerundet	MDF lacquered, top thickness 18 mm, top edges straight, table P4-128 has top of 12 mm; as a standard, MDF top has a cut-out for a wire, additional charge / MDF Lackbeschichtung strukturiert, Plattendicke 18mm, Plattenkanten gerade ausgeführt, Tisch P4-128 mit Plattendicke 12 mm; MDF-Platte standardmäßig mit Kabelausschnitt, gegen Aufpreis 
			
FRAME / GESTELL	tables on disk base / Säulentischbein	frame under the top and the upper part of the leg powder-coated metal / Gestell unter der Tischplatte und Oberteil des Säulentischbeins aus Metall, pulverbeschichtet	lower part of the leg and the disk stainless steel or powder coated metal / Unterteil des Säulentischbeins und Bodenplatte aus rostfreiem Stahl oder pulverbeschicht Stahl

COLLECTION ELEMENTS / ELEMENTE DER KOLLEKTION

SCREENS / WANDSCHIRME

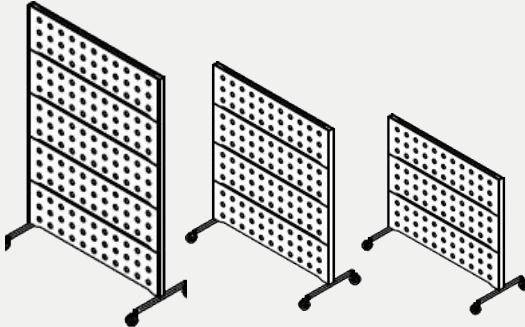
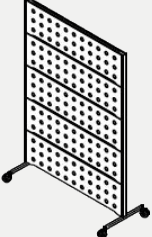
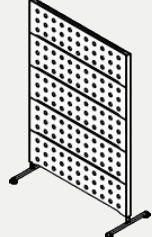
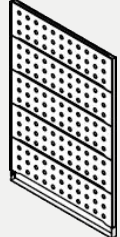
<p>TYPES OF SCREENS /WANDSCHIRM-VARIANTEN</p>	<p>3 heights: / erhältlich in 3 Höhevarianten:</p> <p>type of screen base (wheels or feet) does not influence its height (e.g. 3-panel screen on wheels and on feet has the same height), they are also consistent with the heights of sofas, partition screens, and high CARGO / Untergestellvariante (Rollen bzw. Füße) ist für die Wandschirmhöhe irrelevant (z.B. Wandschirm mit 3 Paneelen hat in der Rollen- und Fußvariante dieselbe Höhe). Die Wandschirme sind auch auf die Höhe von Sofas, Schreibtischblenden sowie von CARGO hoch abgestimmt.</p>	<p>5, 4, and 3 panels per height / 5, 4 und 3 Paneele</p>	
<p>TYPES OF FRAMES FOR SCREENS / UNTERGESTELLVARIANTEN</p>	<p>on PLUS wheels / mit PLUS-ROLLEN</p>	<p>on feet / mit Füßen</p>	<p>on lengthwise skid - fixed to the desktop or table top, cannot be used with tops with height adjustment and sliding tops / Mit Längskufe - befestigt an der Schreibtisch- bzw. Tischplatte. Nicht geeignet für höhenverstellbare bzw. verschiebbare Platten.</p>
			
<p>screens are made of an aluminium frame and upholstered panels and upholstered slats are attached to it / Wandschirme sind aus Alugestell gefertigt, an dem gepolsterte Paneele sowie gepolsterte Seitenleisten befestigt sind.</p>			
<p>delivered mounted, only base with wheels or feet is to be assembled / Lieferung in vormontiertem Zustand, es bleibt nur das Untergestell mit Rollen bzw. Füßen zu montieren.</p>			
<p>powder-coated steel channel bar in the colour of the frame is fixed to the upper edge of the screen, which gives possibility to hang accessories / An dem oberen Rand des Wandschirms ist ein U-Profil aus Stahl, pulverbeschichtet in der Gestellfarbe, zum Aufhängen von Accessories angebracht.</p>			
<p>between the panels there are powder-coated aluminium mouldings in the colour of the screen frame, on the upper edges of the panels accessories can be hung / Zwischen den Paneelen sind Aluleisten, pulverbeschichtet in der Gestellfarbe, angebracht; der obere Rand von Paneelen ist zum Aufhängen von Accessories geeignet.</p>			
<p>all metal elements of the screen, in a standard version, are painted in the same colour / Sämtliche Metallelemente in der Standardvariante haben dieselbe Farbe.</p>			

COLLECTION ELEMENTS / ELEMENTE DER KOLLEKTION

SCREENS / WANDSCHIRME

UPHOLSTERED
PANELS TO
SCREENS AND
WALL PANELS /
STOFFBEZOGENE
PANELE FÜR
WANDSCHIRME UND
WANDPANEELE

screen view / Ansicht

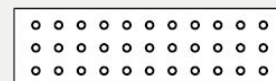
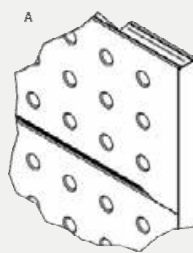
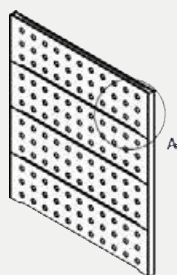

MDF milled dimples of approx. 30 mm diameter in equal distances, regardless of the panel width, panels of various widths differ in terms of the number of holes, panels are upholstered with wool (Agava and Blazer) / MDF gefräst - Einfresungen Durchmesser ca. 30mm, gleichmäßig verteilt, unabhängig von der Breite des Paneels. Anzahl von Bohrungen variiert je nach der Paneelbreite. Mit Wolle gepolstert (Agava bzw. Blazer)

Agava or Blazer upholstery, according to NOTI's fabrics / Stoff Agava bzw. Blazer, gem. NOTI-Farbmuster

sides of the screens are always finished with upholstered mouldings / Paneelseiten sind mit Polsterleisten versehen

all elements of the screen, in a standard version, are upholstered with the same type of upholstery and colour / Sämtliche Wandschirmelemente in der Standardvariante haben denselben Stoff in derselben Farbe

WALL PANELS / WANDPANEELE

WALL PANELS /
WANDPANEELE

wall panels are prepared as ready-made elements to be hanged on the partition screen, available in some size - similar to standing screens: / Wandpaneele sind als fertige Elemente zum Aufhängen an der Wand ausgelegt. Erhältlich in unterschiedlichen Maßvarianten (wie bei Stehwandschirmen):

4 heights: / 4 Höhevarianten: 5, 4, 3, and 2 panels per height / 5, 4, 3 und 2 Paneele

4 width / Bs: / 4 Breitevarianten: 120, 100, 80, and 60 cm / 120, 100, 80 und 60 cm

the wall panel is made of a frame and panels which are hanged on it - as in standing screens / Wandpaneel besteht aus einem Gestell und aufgehängten Paneelen (wie bei Stehwandschirmen).

the entire wall panel is in one type of upholstery and in one colour / Ganzes Wandpaneel hat dieselbe Stoff in derselben Farbe.

between the panels there are powder-covered aluminium mouldings - they function as an too to hang accessories / Zwischen den Paneelen sind pulverbeschichtete Aluleisten zum Aufhängen von Accessories angebracht.

Agava or Blazer upholstery, according to BALMA's fabrics / Stoff Agava bzw. Blazer, gem. BALMA-Farbmuster

SIDE SLAT /
SEITENLEISTE

upholstery side slat Agava or Blazer upholstery, according to NOTI's fabrics / Stoff Seitenleisten Agava bzw. Blazer, gem. NOTI-Farbmuster

5 heights / Höhevarianten: 5,4,3,2 and 1 panel, 5,4,3,2 und 1

COLLECTION ELEMENTS / ELEMENTE DER KOLLEKTION

ARMCHAIR, SOFAS, SCREEN / SESSEL, SOFAS, BILDSCHIRM

SEAT AND BACKREST / SITZ UND RÜCKENLEHNE	plywood structure covered with high density polyurethane foam, upholstered, seat height 45 cm, seat depth 46 cm / Struktur aus Sperrholz mit hochdichtem Polyurethanschaum überzogen, gepolstert, Sitzhöhe 45 cm, Sitztiefe 46 cm
SIDES, BACK / SEITEN, RÜCKENSEITE	plywood structure covered with polyurethane foam, upholstered / Sperrholzstruktur mit Polyurethanschaum überzogen, gepolstert
LEGS / BEINE	powder coated metal matt black RAL 9005 / Pulverbeschichtetes Metall, mattschwarz RAL 9005
CASTORS / ROLLEN	castors 2 with brake, 2 without, black / Rollen 2 mit Bremse, 2 ohne, schwarz
SCREEN / BILDSCHIRM	plywood structure covered with polyurethane foam, upholstered, attached to the sides of the high sofa with a common leg with the sofa and in the upper part with metal connectors - matt black RAL 9005 / Struktur aus Sperrholz mit Polyurethanschaum überzogen, gepolstert, an den Seiten des Hochsofas mit einem gemeinsamen Bein mit dem Sofa und im oberen Teil mit Metallverbindern befestigt - mattschwarz RAL 9005
PACKAGING / VERPACKUNG	shipping in disassembled condition / Lieferung erfolgt nicht montiert

ROTATING TABLE // DREHBARER TISCH

TOP / TISCHPLATTE	360 degrees rotatable table mounted under the seat in any place, thickness 18 mm / 360 Grad drehbare Tischplatte, an beliebiger Stelle unter dem Sitz montiert, Dicke 18 mm
FRAME / GESTELL	powder coated metal frame in matt black RAL 9005 / pulverbeschichtetes Metallgestell in Mattschwarz RAL 9005

TABLE / TISCH

TOP / TISCHPLATTE	Version 1	Version 2
	melamine board, 25 mm thick, rounded corners / Melaminplatte, 25 mm Dicke, abgerundete Ecken	natural veneer, 25 mm thick, straight edges, rounded corners / Naturfurnier, 25 mm Dicke, gerade Kanten, abgerundete Ecken
FRAME / GESTELL	tables on disk base / Säulentischbein	
	Version 1 leg and the disk powder coated metal / Säulentischbeins und Bodenplatte aus pulverbeschichtetes Metall	Version 2 frame under the top and the upper part of the leg powder coated metal lower part of the leg and the disk stainless steel - additional charge option / Gestell unter der Tischplatte und Oberteil des Säulentischbeins aus Metall, pulverbeschichtet, Unterteil des Säulentischbeins und Tellerfuß aus Edelstahl - Aufpreisoption

ADDITIONAL INFORMATION / ZUSÄTZLICHE INFORMATIONEN

All upholstered elements are made of one type of upholstery. / Alle Polster Elemente bestehen aus einer Polsterart.

ACCESSORIES

Balma PLUS system offers many types of accessories which will make office work easier, increase comfort of work and efficiency / Das SYSTEM Balma PLUS bietet umfangreiches Accessories zur Erleichterung der Büroarbeit sowie zur Steigerung des Komforts und der Effektivität.

TYPES OF ACCESSORIES / ZUBEHÖR-VARIANTEN	extras: tops, rail top units, front shield, panels, foot-rest, pillows / Accessories: Tischplatten, Aufsatzschiene, Drehblende, Paneele, Fußbank, Kissen
--	--

COLLECTION ELEMENTS / ELEMENTE DER KOLLEKTION

DESCRIPTIONS OF PARTICULAR TYPES OF ACCESSORIES /
BESCHREIBUNG EINZELNER ELEMENTE

UPPER SECTION RAIL / AUFSATZSCHIENE	<p>upper section rail, upholstered with the front and rear magnetic function, made of powder-painted sheet metal plate, MDF upholstered panels fixed directly to the desktop using vices, height above the desktop 20 cm, distance between the top and the lower edge 9 cm, on an upper slat it is possible to place a tray P4-611; to choose from: type and upholstery colour, colour of the frame, colour of the internal MDF varnish / Aufsatzschiene, gepolstert, mit Magnetfunktion an der Vorder- und Hinterseite, aus pulverbeschichtetem Blech, MDF-Paneele gepolstert. Befestigung direkt an der Schreibtischplatte mit kleinen Metallschraubstöcken. Höhe über der Tischplatte 20 cm, Abstand zwischen der Tischplatte und dem unteren Rand 9 cm, die obere Leiste für das Tablett P4-613 geeignet. Zur Wahl: Art und Farbe der Stoffes, Farbe des Gestells, Farbe der Lackbeschichtung von MDF innen.</p>
ROTATING SCREEN / DREHBLLENDE	<p>rotating screen, fixed to the desktop using vices, made of press felt, upholstered on both sides, to choose from: type, upholstery colour, and colour of powder-painted metal Available in left and right version, can be installed to the tops made of MFC, can be installed on a desk or table edge or between the double tops, 360-degree pivot in any direction. NOTE: due to the dimensions of the screen it might not always be possible to reach full pivot / Drehblende, befestigt an der Schreibtischplatte mit kleinen Metallschraubstöcken, aus gepresstem Filz, beiderseitig gepolstert. Zur Wahl: Art und Farbe der Stoff sowie Farbe der Pulverbeschichtung von Metall. Erhältlich in linker und rechter Ausführung. Geeignet zur Befestigung an melaminbeschichteten Tischplatten. Montage am Schreibtisch- bzw. am Tischrand oder zwischen Doppeltischplatten möglich. Umdrehung um 360° in jeder Richtung. WICHTIG! Aufgrund von Maßen ist eine volle Umdrehung der Blende nicht immer möglich.</p> <p>radius of rotation of the screen: 57,5 cm / Drehgrad: 57,5 cm version: right and left / Variante: rechts und links</p>
FOOTREST / FUSSBANK	<p>footrest, made of fi 25 mm pipes and sheet metal plate, powder-painted - to be chosen: frame colour, covers made of plastic are on the pipes, black height of the CARGO differ depending on the side it lies on / Fußbank, gefertigt aus Rohren fi 25 mm sowie aus Blech, pulverbeschichtet - zur Wahl: Farbe des Gestells, an Rohren sind Kunststoffabdeckungen aufgesetzt, Farbe Schwarz. Die Höhe der Fußbank hängt davon ab, auf welcher Seite sie liegt</p>

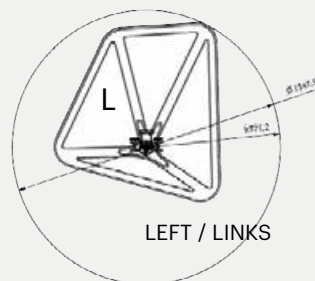

DESCRIPTIONS OF PARTICULAR TYPES OF ACCESSORIES /
BESCHREIBUNGEN DER EINZELNENEN ACCESSORIESARTEN

CUSHION / KISSEN	pillow for cabinets / Schrankkissen	made of polyurethane foam of larger density, upholstered / PURSchaumstoff mit höherer Dichte, gepolstert	designed to be placed on a top ring of the cabinet, between the sides and the railing - which prevents them from moving / zum Aufsetzen auf dem Oberaufsatz von Schrank, zwischen den Seiten und dem Reling - so dass sie nicht verrutschen.
DESK ACCESSORIES / SCHREIBTISCHZUBEHÖR	types of desk accessories: / Accessoriesvarianten:	a block for pens and pieces of paper, made of raw wood / Stifthalter und Zettelkasten, Rohholz.	
OTHER / SONSTIGE	extras such as mediaports and cable passages normally available for all tops with no collision with the frame under the desktop. / Solches Accessories, wie z.B. Tischanschlüsse und Kabeldurchlässe sind standardmäßig für alle Tischplatten erhältlich, sofern keine Kollision mit dem Gestell unter der Tischplatte eintritt.		

FINISHING / AUSFÜHRUNG

DESKS WITH HEIGHT ADJUSTMENT / SCHREIBTISCHE MIT HÖHENVERSTELLUNG

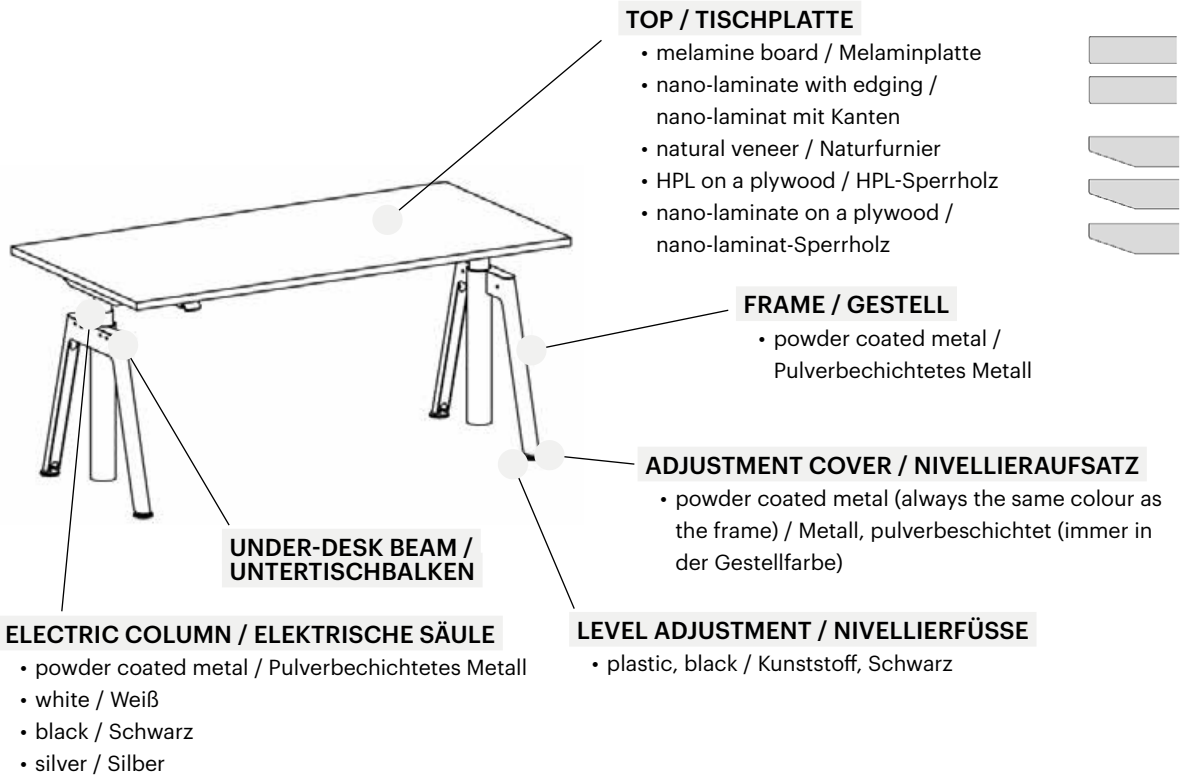

FINISHING / AUSFÜHRUNG

BODY / KORPUS

- melamine board / Melamine Platte
- horizontal grain / Maserungsverlauf horizontal

HANDRAIL SLAT / GRIFFLEISTE

- powder coated metal / Pulverbeschichtetes Metall

RAILING / RELING

- powder coated metal / Pulverbeschichtetes Metall

DRAWER FRONT / SCHUBLADENFRONT

- melamine board / Melamin Platte

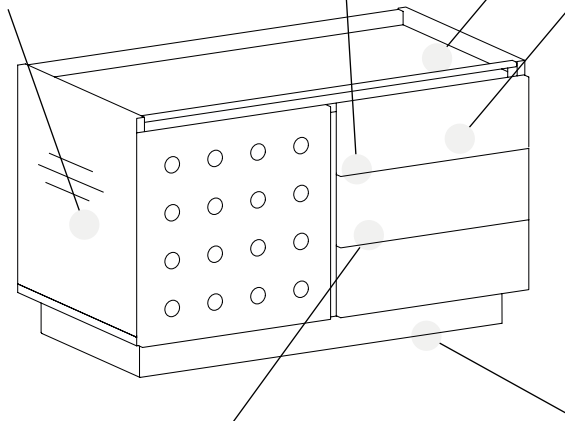

DOOR FRONT / SCHRANKTÜR

- melamine board / Melamin Platte
- lacquered MDF Matt – milled / lackiert MDF Matt – gefräst

METAL BASE POWDER-PAINTED / METALLSOCKEL PULVERBESCHICHTET



or / oder **PLUS PLASTIC WHEELS / KUNSTSTOFFROLLEN PLUS**

- black or white / Schwarz oder Weiß

BODY / KORPUS

- melamine board / Melamine Platte
- horizontal grain / Maserungsverlauf horizontal

OPTION – ADDITIONAL TOP (ADJUSTABLE HEIGHT) / OPTIONAL – ZUSÄTZLICHE TISCHPLATTE (HÖHENVERSTELLBAR)

- melamine board / Melamine Platte 
- natural veneer / Naturfurnier 
- HPL on a plywood / HPL-Sperrholzplatte 

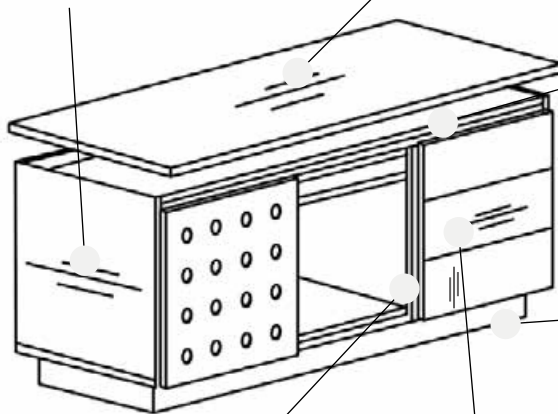

RAILING / RELING

- powder coated metal / Pulverbeschichtetes Metall

METAL BASE POWDER-PAINTED / METALLSOCKEL PULVERBESCHICHTET

or / oder **PLUS PLASTIC WHEELS / KUNSTSTOFFROLLEN PLUS**

- black or white / Schwarz oder Weiß

HANDRAIL SLAT / GRIFFLEISTE

- powder coated metal / Pulverbeschichtetes Metall

DRAWER FRONT / SCHUBLADENFRONT

- melamine board / Melamin Platte

FINISHING / AUSFÜHRUNG

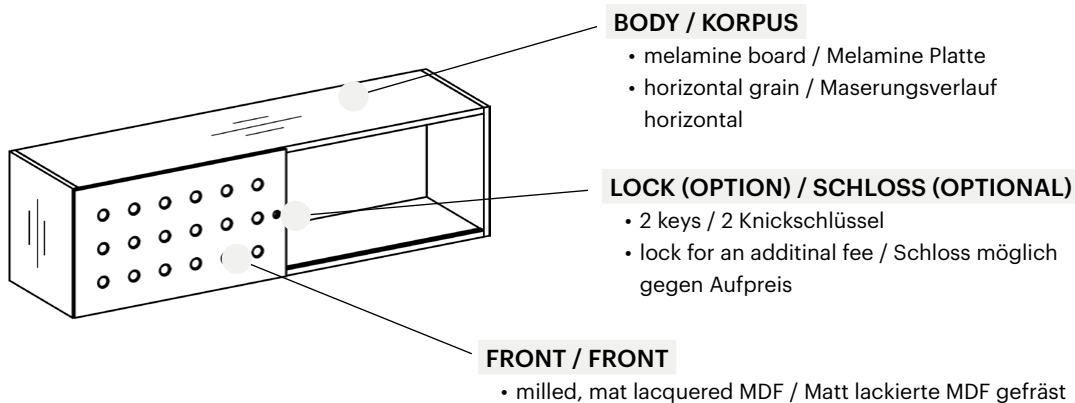

TABLES ON DISC LEGS / BESPRÜCHUNGSTISCHE

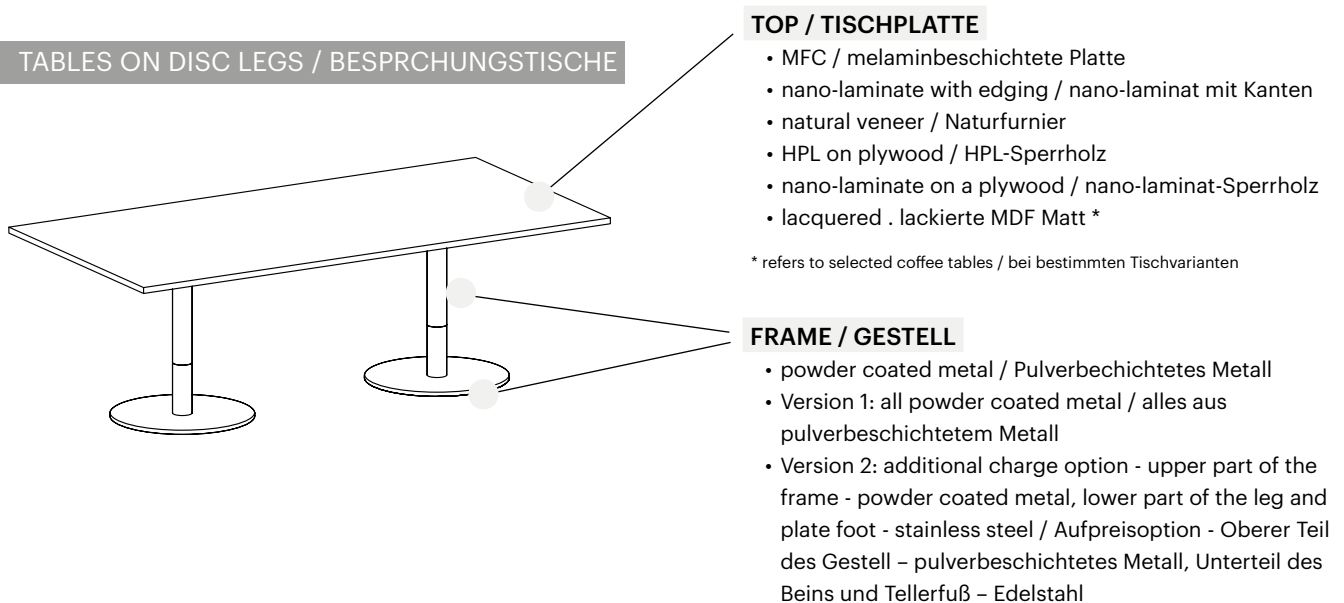

TABLES / TISCHE

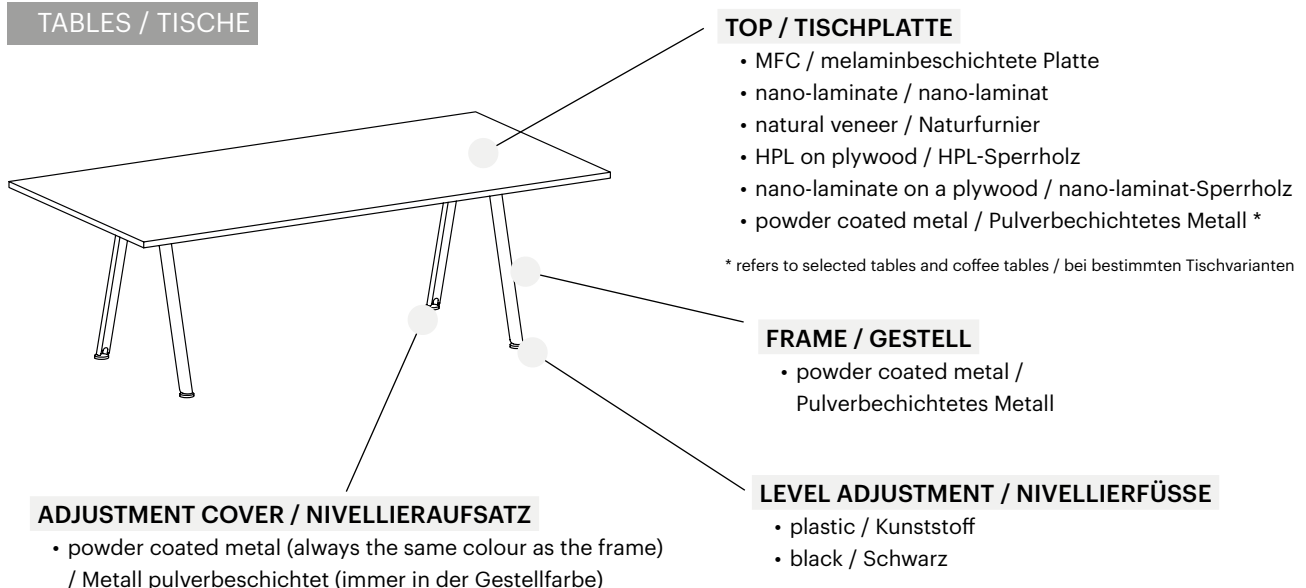

FINISHING / AUSFÜHRUNG

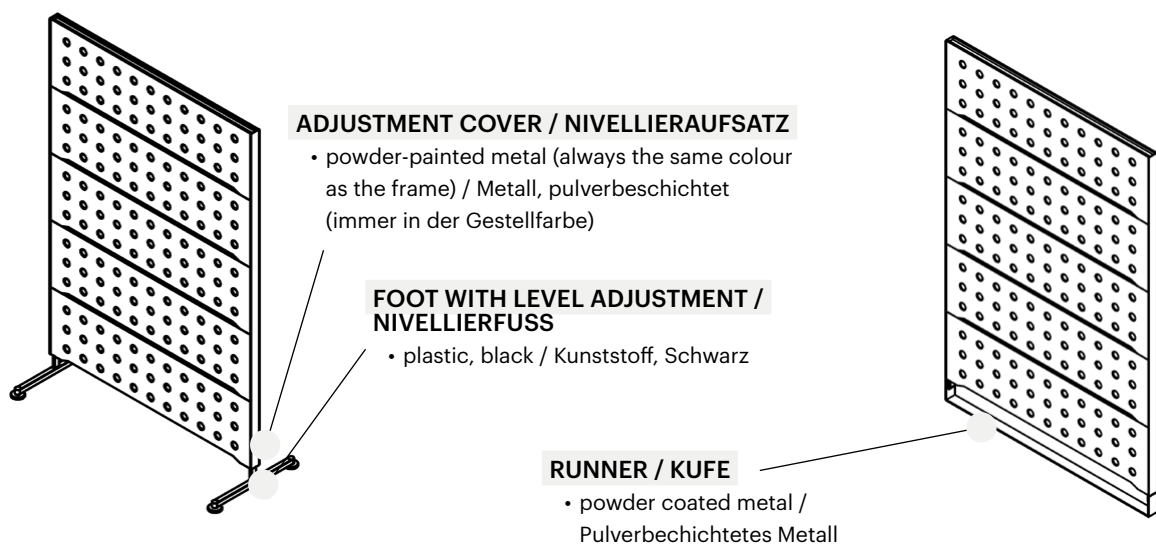
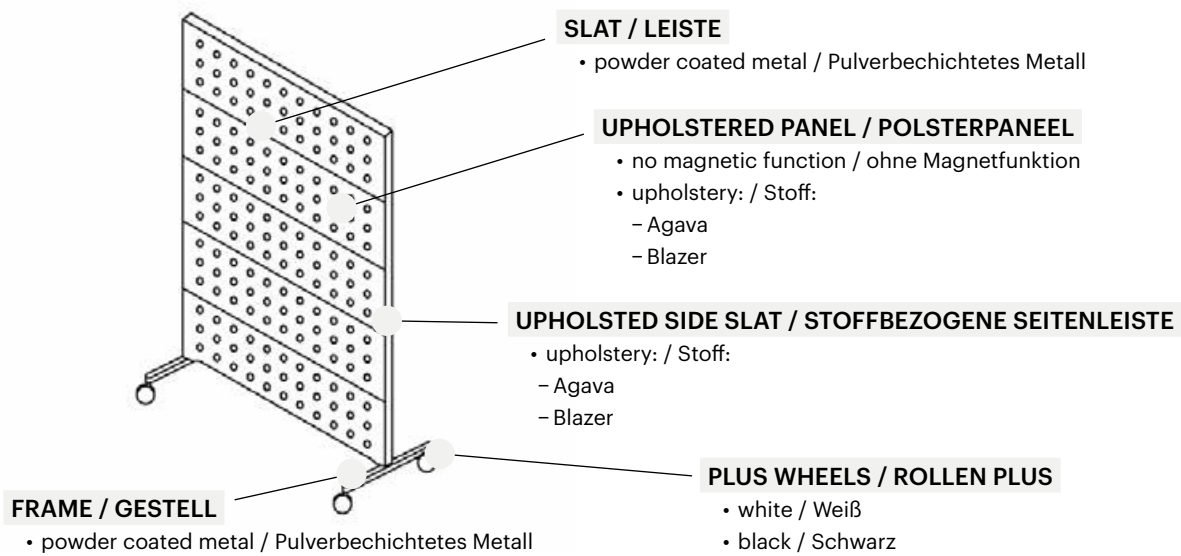

FINISHING / AUSFÜHRUNG

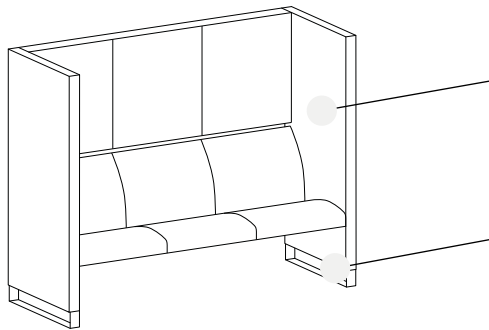

UPHOLSTERED ELEMENTS / STOFFELEMENTE

- upholstery according to Balma and Noti fabrics / Stoffe gem. Balma und Noti-Farbmuster

RUNNER / KUFE

- powder coated metal / Pulverbeschichtetes Metall

FEET / FÜSSE

- plastic / Kunststoff
- without level adjusting / ohne Niveaueausgleich

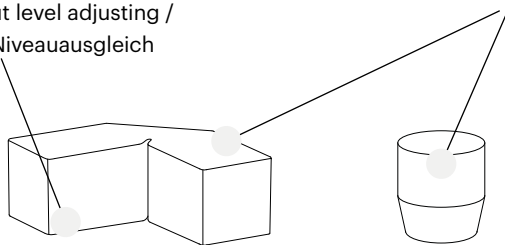

UPHOLSTERED ELEMENTS / STOFFELEMENTE

- upholstery according to Balma and Noti fabrics / Stoffe gem. Balma und Noti-Farbmuster

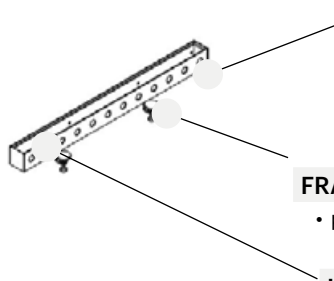

UPHOLSTERED PANEL / STOFFPANEEL

- magnetic function / Magnetfunktion
- upholstery: / Stoffe:
 - Agava
 - Blazer

FRAME AND FIXING / GESTELL UND BEFESTIGUNG

- powder coated metal / Pulverbeschichtetes Metall

LACQUERED MDF / MDF LACKBESCHICHTUNG

- mat lacquered MDF / Matt lackierte MDF

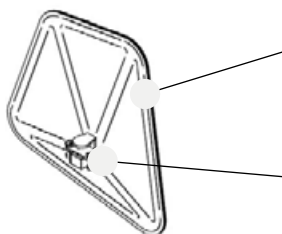

UPHOLSTERED SCREEN / STOFFBLENDE

- upholstery: / Stoffe:
 - Agava
 - Blazer

FIXING / BEFESTIGUNG

- powder coated metal / Pulverbeschichtetes Metall

AVAILABLE COLOURING / FARBEN

MELAMINE BOARD / MELAMIN

- full colour according to BALMA colouring pattern / alle Farben des Balma Materialmuster

NATURAL VENEER / NATURFURNIERE

- full colour according to BALMA colouring pattern / alle Farben des Balma Materialmuster

NANO-LAMINATE WITH EDGING / NANO-LAMINAT MIT KANTEN

- white / Weiß 3101
- black / Schwarz 3102

NANO-LAMINATE ON PLYWOOD /NANO-LAMINAT - SPERRHOLZ

- white / Weiß 3101
- black / Schwarz 3102

HPL ON PLYWOOD / HPL - SPERRHOLZ

- black / Schwarz 1100
- white / Weiß 2700

LACQUERED / LACKIERTE MDF MATT

- full colour according to BALMA colouring pattern / alle Farben des Balma Materialmuster

POWDER COATED METAL / PULVERBESCHICHTETES METALL

- full colour according to BALMA colouring pattern / alle Farben des Balma Materialmuster

UPHOLSTERED PANEL (SCREENS, ACCESSORIES) / STOFFPANEEL (WANDSCHIRME, ZUBEHÖR)

- upholstery according to Balma's fabrics / Stoffbezug gem. Balma Farbmuster
 - Agava / Agava
 - Blazer / Blazer

UPHOLSTERED ELEMENTS / SOFT-SEATING

- Standard
- O: Cubo, Lars, Mossa, Storm, Terra
- A: Cura, Era, Medley
- B: Agava (Wool), Main Line Flax, Stamskin, Step, Step Melange, Valencia
- C: Blazer, Morph, Remix 3, Silvertex
- D: Credo, Hallingdal 65, Steelcut Trio 3
 - Design
- B: Aosta, Aries, Main Line Twist, Prato, Vel (Charleston)
- C: Capture, Granola, Mood, Moulin, Synergy
- D: Bhaluka, Carnival, Cleo, Sera
- E: Arco, Gorky, Montreal
- F: Arda
- G: Baru, Coda 2, Sprinkles

ADDITIONAL CHARGE / AUFPREIS

	NET PRICE IN EUR / PREIS NETTO EUR
- spiral cable for the desk / Spiralkabel für den Schreibtisch	+ 30 EUR
- lock on cabinet fronts / Schloss an Schrankfronten	+ 20 EUR
- cut-out for a wire in MDF tops / Ausschnitt für ein Kabe in MDF-Platten	+ 23 EUR

STAINLESS STEEL / EDELSTAHL

- plate leg per piece / Tellerfuß pro Stück 57 EUR

PRICES / PREISE

EXECUTIVE WITH HEIGHT ADJUSTMENT / CHEFZIMMER-SCHREIBTISCH MIT HÖHENVERSTELLUNG

VIEW / ANSICHT	DIMENSIONS (in cm) / MASSE (in cm)			CATALOGUE NO. / KATALOG NR	NET PRICE IN EUR / PREIS NETTO EUR						
	Width / B	Depth / T	Height / H		natural veneer top / Tischplatte Naturfurnier			NANO HPL on plywood / NANO HPL auf Sperrholz	HPL on plywood / HPL auf Sperrholz	Nano-laminate with edging / Nano-Laminat mit Kanten	melamine / melaminbeschichtet*
					Gr. 1	Gr. 2	Gr. 3				
	200	100	65-130	P4-004	2 382	2 451	2 521	3 095	2 773	2 029	1 642
	180	90		P4-005	2 362	2 432	2 502	3 009	2 754	1 904	1 628
	160	90		P4-006	2 340	2 410	2 479	2 952	2 731	1 888	1 614

CABINETS / SCHRÄNKE

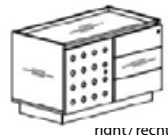
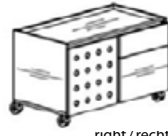
VIEW / ANSICHT	DIMENSIONS (in cm) / MASSE (in cm)			CATALOGUE NO. / KATALOG NR	NET PRICE IN EUR / NETTOPREIS IN €		DESCRIPTION / BESCHREIBUNG
	Width / B	Depth / T	Height / H		drawers / Schubladen MFC		
					front MDF lacquered / lackiert Matt	front MFC	
 right/rechts	90,5	50	55,5	P4-302	1 253	723	cabinet on wheel or base, with 1 door and 3 drawers, to choose left / right / Rollen- bzw. Sockelschrank, mit 1 Flügeltür und 3 Schubladen, linke/rechte Variante erhältlich
 right/rechts	90,5	50	55,5	P4-303			cabinet on wheel or base, with 1 door and 1 drawer for hanging files, to choose left / right / Rollen- bzw. Sockelschrank, mit 1 Flügeltür, 1 Schublade, 1 Schublade für Hängemappen, linke/rechte Variante erhältlich

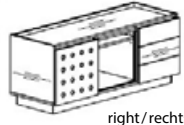
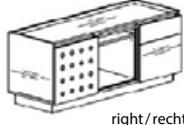
VIEW / ANSICHT	DIMENSIONS (in cm) / MASSE (in cm)			CATALOGUE NO. / KATALOG NR	NET PRICE IN EUR / NETTOPREIS IN €		DESCRIPTION / BESCHREIBUNG
	Width / B	Depth / T	Height / H		drawers / Schubladen MFC		
					lacquered / lackiert MDF Matt	MFC	
 right/rechts	135	50	55,5	P4-304	1 297	1 168	cabinet on wheels or base with 1 sliding door and 3 drawers / Rollen- bzw. Sockelschrank mit 1 Schiebetür und 3 Schubladen
 right/rechts	135	50	55,5	P4-305			cabinet on wheels or base with 1 sliding door and 1 drawer and a drawers for hanging files / Rollen- bzw. Sockelschrank mit 1 Schiebetür und 1 Schublade und 1 Hängemappenschublade

PRICES / PREISE

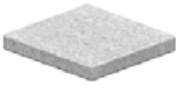
CUSHION / KISSEN												
VIEW / ANSICHT	DIMENSIONS (in cm) / MASSE (in cm)			CATALOGUE NO. / KATALOG NR.	NET PRICE IN EUR / NETTOPREIS in €							
	Width / B	Depth / T	Height / H		fabric group / Stoff Gruppe							
					O	A	B	C	D	E	F	G
	44	44	5,5	P4-647	138	147	161	179	207	230	192	286

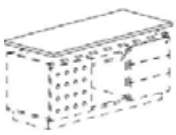
ADDITIONAL TOP FOR CABINETS / ZUSÄTZLICHE TISCHPLATTE FÜR SCHRÄNKE P4-304 P4-305											
VIEW / ANSICHT	DIMENSIONS (in cm) / MASSE (in cm)			CATALOGUE NO. / KATALOG NR.	NET PRICE IN EUR / NETTOPREIS in €						
	Width / B	Depth / T	Height / H		melamine / melaminbeschichtet	natural veneer / Naturfurnier					
						Gr. 1	Gr. 2	Gr. 3			
	135	56,5	65-85	ADDITIONAL TOP FOR P4-304 AND P4-305 CABINETS	150	224	250	276			

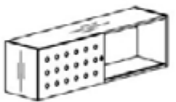
HANGING CABINET / HÄNGESCHRANK						
VIEW / ANSICHT	DIMENSIONS (in cm) / MASSE (in cm)			CATALOGUE NO. / KATALOG NR.	NET PRICE IN EUR / NETTOPREIS in €	DESCRIPTION / BESCHREIBUNG
	Width / B	Depth / T	Height / H		body melamine, sliding door, MDF lacquered / Korpus melaminbeschichtet, Schiebetüren MDF lackiert	
	135	34	39	P4-311	528	hanging cabinet with sliding doors / Hängeschränk mit Schiebetür

PRICES / PREISE

CONFERENCE TABLES / KONFERENZTISCHE



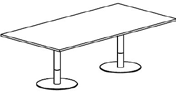

VIEW / ANSICHT	DIMENSIONS (in cm) / MASSE (in cm)			CATALOGUE NO. / KATALOG NR	NET PRICE IN EUR / NETTOPREIS in €						DESCRIPTION / BESCHREIBUNG	REMARKS / DETAILS	
	Width / B	Depth / T	Height / H		natural veneer top / Tischplatte Naturfurnier			NANO HPL on plywood / NANO HPL auf Sperrholz	HPL on a plywood / HPL-Sperholz	Nano-HPL with edging / Nano-HPL mit Kanten			MFC / melamin
					Gr. 1	Gr. 2	Gr. 3						
	240	120	74	P4-101	1 020	1 120	1 220	-	-	1 172	679	rectangular conference table, frame as in an executive desk, without height adjustment / Konferenztisch rechteckig, Gestell wie beim Chefzimmer-Schreibtisch, ohne Höhenverstellung	
	220	110		P4-102	999	1 099	1 199	-	-	1 158	665		
	200	100		P4-103	912	987	1 062	1 655	1 413	1 084	647		
	180	90		P4-104	852	927	1 002	1 446	1 280	924	612		

CONFERENCE TABLES / KONFERENZTISCHE

VIEW / ANSICHT	DIMENSIONS (in cm) / MASSE (in cm)			CATALOGUE NO. / KATALOG NR	NET PRICE IN EUR / NETTOPREIS in €						DESCRIPTION / BESCHREIBUNG	REMARKS / DETAILS	
	Width / B	Depth / T	Height / H		natural veneer top / Tischplatte Naturfurnier			NANO HPL on plywood / NANO HPL auf Sperrholz	HPL on a plywood / HPL-Sperholz	Nano-HPL with edging / Nano-HPL mit Kanten			MFC / melamin
					Gr. 1	Gr. 2	Gr. 3						
	240	120	74	P4-113	1 376	1 476	1 576	-	-	1 568	1 098	conference table on two disk bases, rectangular top / Konferenztisch auf 2 Bodenplatten, Tischplatte rechteckig	pipes fi 90 mm, disk fi 600 mm, thickness 10 mm / Säule fi 90 mm, Bodenplatte fi 600mm, Stärke 10mm
	220	110		P4-114	1 291	1 391	1 491	-	-	1 472	997		pipes fi 80mm, disk fi 600 mm, thickness 10 mm / Säule fi 80mm, Bodenplatte fi 600mm, Stärke 10mm
	200	100		P4-115	1 159	1 234	1 309	1 495	1 256	1 367	946		pipes fi 70mm, disk fi 500mm, thickness 10 mm / Säule fi 70mm, Bodenplatte fi 500mm, Stärke 10mm
	180	90		P4-116	950	1 025	1 100	1 322	1 157	1 140	839		pipes fi 70mm, disk fi 500mm, thickness 10 mm / Säule fi 70mm, Bodenplatte fi 500mm, Stärke 10mm

PRICES / PREISE

HIGH CONFERENCE TABLES / KONFERENZTISCHE STEHTISCHE

VIEW / ANSICHT	DIMENSIONS (in cm) / MASSE (in cm)			CATALOGUE NO. / KATALOG NR	NET PRICE IN EUR / NETTOPREIS in €							DESCRIPTION / BESCHREIBUNG	REMARKS / DETAILS
	Width / B	Depth / T	Height / H		natural veneer top / Tischplatte Naturfurnier			NANO HPL on plywood / NANO HPL auf Sperrholz	HPL on a plywood / HPL-Sperrholz	Nano-HPL with edging / Nano-HPL mit Kanten	MFC / melamin		
					Gr. 1	Gr. 2	Gr. 3						
	200	100	110	P4-117	1 377	1 452	1 527	1 697	1 522	1 350	928	high conference table on two disk bases, single rectangular top / Konferenztisch Hochvariante auf 2 Bodenplatten, Tischplatte Einzelvariante rechteckig	pipes fi 70mm, disk fi 500mm, thickness 10 mm / Säule fi 70mm, Bodenplatte fi 500mm, Stärke 10mm
	180	90		P4-118	1 338	1 413	1 488	1 569	1 463	1 216	918		pipes fi 70mm, disk fi 500mm, thickness 10 mm / Säule fi 70mm, Bodenplatte fi 500mm, Stärke 10mm
	250	100	110	P4-119	2 087	2 187	2 287	-	-	2 023	1 576	high conference table on two disk bases, double rectangular top / Konferenztisch Hochvariante auf 2 Bodenplatten, Tischplatte Doppelvariante rechteckig	top 18 mm, space between tops 76 mm, cable management in a leg. Pipes fi 90 mm, disk fi 600 mm, thickness 15 mm, with level adjustment in the range of 10 mm / Tischplatte 18mm, Plattenzwischenraum 76mm, Kabelführung im Säulentischbein. Säule fi 90mm, Bodenplatte fi 600mm, Stärke 15mm, Nivellierfüße Einstellbereich 10mm;
	220	90		P4-120	1 854	1 954	2 054	-	-	2 007	1 558		
	100		110	P4-121	880	955	1 030	1 246	1 123	-	583	high round table on a disk leg, round top / Hochtisch Rundvariante auf 1 Bodenplatte, Tischplatte rund	pipes fi 90 mm, disk fi 600 mm, thickness 10 mm, slides / Säule fi 90mm, Bodenplatte fi 600mm, Stärke 10mm, Gleitelemente
	80			P4-122	898	948	998	1 241	1 151	-	588		pipes fi 70mm, disk fi 500mm, thickness 10 mm / Säule fi 70mm, Bodenplatte fi 500mm, Stärke 10mm
	60			P4-123	816	866	916	1 216	1 126	-	570		pipes fi 50mm, disk fi 400mm, thickness 10 mm / Säule fi 50mm, Bodenplatte fi 400mm, Stärke 10mm

PRICES / PREISE



HEIGHT ADJUSTABLE CONFERENCE TABLES / KONFERENZTISCHE MIT HÖHENVERSTELLUNG

VIEW / ANSICHT	DIMENSIONS (in cm) / MASSE (in cm)			CATALOGUE NO. / KATALOG NR	NET PRICE IN EUR / NETTOPREIS in €					DESCRIPTION / BESCHREIBUNG	REMARKS / DETAILS	
	Width / B	Depth / T	Height / H		natural veneer top / Tischplatte Naturfurnier			HPL on a plywood / HPL-Sperrholz	Nano-HPL with edging / Nano-HPL mit Kanten			MFC / Melamin
					Gr. 1	Gr. 2	Gr. 3					
	200	100	65-130	P4-141	2 009	2 084	2 159	2 224	2 179	1 453	conference table on two disk bases, rectangular top / Konferenztisch auf 2 Bodenplatten, Tischplatte rechteckig	pipes fi 80mm, disk fi 600mm, thickness 15 mm / Säule fi 80mm, Bodenplatte fi 600mm, Stärke 15mm
	180	90		P4-142	1 972	2 047	2 122	2 187	2 036	1 435		

ROUND CONFERENCE TABLE / KONFERENZTISCHE RUNDVARIANTE

VIEW / ANSICHT	DIMENSIONS (in cm) / MASSE (in cm)			CATALOGUE NO. / KATALOG NR	NET PRICE IN EUR / NETTOPREIS in €					DESCRIPTION / BESCHREIBUNG	REMARKS / DETAILS	
	Width / B	Depth / T	Height / H		natural veneer top / Tischplatte Naturfurnier			NANO HPL on plywood / NANO HPL auf Sperrholz	HPL on a plywood / HPL-Sperrholz			MFC / Melamin
					Gr. 1	Gr. 2	Gr. 3					
	120		74	P4-124	646	721	796	-	811	552	conference table on a disk leg, round top / Konferenztisch auf 1 Bodenplatte, Tischplatte rund	pipes fi 90 mm, disk fi 600 mm, thickness 10 mm / Säule fi 90mm, Bodenplatte fi 600mm, Stärke 10mm
	100			P4-125	575	625	675	714	741	481		pipes fi 80mm, disk fi 600 mm, thickness 10 mm / Säule fi 80mm, Bodenplatte fi 600mm, Stärke 10mm
	80			P4-140	532	582	632	616	689	446		pipes fi 50mm, disk fi 500 mm, thickness 10 mm / Säule fi 50mm, Bodenplatte fi 500mm, Stärke 10mm

COFFEE TABLES / COUCHTISCHE

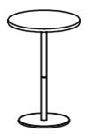
VIEW / ANSICHT	DIMENSIONS (in cm) / MASSE (in cm)			CATALOGUE NO. / KATALOG NR	NET PRICE IN EUR / NETTOPREIS in €					DESCRIPTION / BESCHREIBUNG	REMARKS / DETAILS
	Width / B	Depth / T	Height / H		natural veneer top / Tischplatte Naturfurnier			MFC / Melamin-beschichtet	lacquered / lackierte MDF Matt		
					Gr. 1	Gr. 2	Gr. 3				
	80		40	P4-126	479	529	579	385	574	coffee table on a disk leg, round top / Säulenbein-Kaffeetisch, Tischplatte rund	top 18mm, pipes fi 40mm, disk fi 500mm, thickness 10 mm, slides / Tischplatte 18mm, Säule fi 40mm, Bodenplatte fi 500mm, Stärke 10mm, Gleitelemente
	60		40	P4-127	453	503	553	359	549		top 18mm, pipes fi 40mm, disk fi 400mm, thickness 10 mm, slides / Tischplatte 18mm, Säule fi 40mm, Bodenplatte fi 400mm, Stärke 10mm, Gleitelemente
	40		60	P4-128	-			-	549		top in lacquered MDF 12 mm, pipes fi 30mm, disk fi 280mm, thickness 10 mm, slides / Tischplatte MDF Lackbeschichtung strukturiert 12 mm, Säule fi 30mm, Bodenplatte fi 280mm, Stärke 10mm, Gleitelemente
	50			P4-129	462	487	512	365	557	top in lacquered MDF 12 mm, pipes fi 30mm, disk fi 280mm, thickness 10 mm, slides / MDF Lackbeschichtung strukturiert 12 mm, Säule fi 30mm, Bodenplatte fi 280mm, Stärke 10mm, Gleitelemente	

PRICES / PREISE

SCREENS / WANDSCHIRME

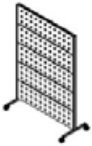
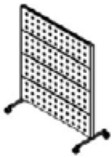
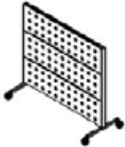
VIEW / ANSICHT	DIMENSIONS (in cm) / MASSE (in cm)			CATA-LOGUE NO. / KATALOG NR	NET PRICE IN EUR / NETTOPREIS in €						DESCRIPTION / BESCHREIBUNG
	Width / B	Depth of the panel / total Depth / T Paneel / T gesamt	Height (+/- 2 mm) / H (+/- 2 mm)		on wheels / rollen-variante		on feet / fussvariante		on lengthwise skid / kufenvariante		
					Agava	Blazer	Agava	Blazer	Agava	Blazer	
	120	5/48,2*	184,2	P4-201	1 509	1 701	1 462	1 654	1 489	1 680	5-panel screen / 5-Wandschirm
	100	5/48,2*		P4-202	1 405	1 596	1 358	1 549	1 378	1 568	
	80	5/48,2*		P4-203	1 267	1 457	1 219	1 410	1 234	1 424	
	60	5/48,2*		P4-204	1 176	1 368	1 129	1 321	1 136	1 328	
	120	5/48,2*	150	P4-205	1 219	1 365	1 172	1 318	1 198	1 346	4-panel screen / 4-Wandschirm
	100	5/48,2*		P4-206	1 155	1 301	1 109	1 254	1 128	1 275	
	80	5/48,2*		P4-207	1 029	1 176	983	1 129	998	1 143	
	60	5/48,2*		P4-208	960	1 106	912	1 058	920	1 066	
	120	5/48,2*	115	P4-209	965	1 063	918	1 015	946	1 044	3-panel screen / 3-Wandschirm
	100	5/48,2*		P4-210	899	996	852	949	872	970	
	80	5/48,2*		P4-211	800	898	753	851	767	865	
	60	5/48,2*		P4-212	742	840	696	793	704	802	

* 5 – depth of the panel, 48,2 – depth of the panel with a base / * 5 – Tiefe Paneel, 48,2 – Tiefe Paneel mit Gestell

PRICES / PREISE

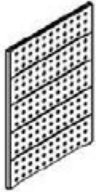
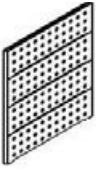
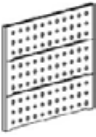
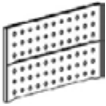
WALL PANELS / WANDPANEELE							
VIEW / ANSICHT	DIMENSIONS (in cm) / MASSE (in cm)			CATALOGUE NO. / KATALOGNR	NET PRICE IN EUR / NETTOPREIS in €		DESCRIPTION / BESCHREIBUNG
	Width / B	Depth of the panel / Tiefe Paneel	Height (+/- 2mm) / H (+/- 2mm)		Agava	Blazer	
	120	4,2	174	P4-235	961	1 062	5-panel wall panel / 5-Wandpaneel
	100			P4-236	854	939	
	80			P4-237	764	834	
	60			P4-238	680	734	
	120	4,2	140	P4-239	864	965	4-panel wall panel / 4-Wandpaneel
	100			P4-240	770	854	
	80			P4-241	688	759	
	60			P4-242	613	666	
	120	4,2	104	P4-243	719	819	3-panel wall panel / 3-Wandpaneel
	100			P4-244	639	723	
	80			P4-245	567	636	
	60			P4-246	500	554	
	120	4,2	70	P4-247	621	693	2-panel wall panel / 2-Wandpaneel
	100			P4-248	554	701	
	80			P4-249	489	496	
	60			P4-250	432	485	



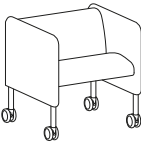

SIDE SLATS TO WALL PANELS / SEITENLEISTE AN DEN WANDPANEEL							
VIEW / ANSICHT	DIMENSIONS (in cm) / MASSE (in cm)			CATALOGUE NO. / KATALOG NR	NET PRICE IN EUR / NETTOPREIS in €		DESCRIPTION / BESCHREIBUNG
	Width / B	Depth of the panel / Tiefe Paneel	Height (+/- 2mm) / H (+/- 2mm)		Agava	Blazer	
	4,2	1	174	P4-251	215	263	side slat to 5 panels / Seitenleiste bis 5 Wandpaneel
			140	P4-252	187	226	side slat to 4 panels / Seitenleiste bis 4 Wandpaneel
			104	P4-253	161	191	side slat to 3 panels / Seitenleiste bis 3 Wandpaneel
			70	P4-254	128	150	side slat to 2 panels / Seitenleiste bis 2 Wandpaneel
			35	P4-255	100	110	side slat to 1 panel / Seitenleiste bis 1 Wandpaneel

PRICES / PREISE

ARMCHAIR / SESSEL

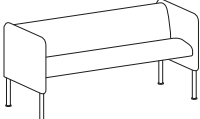
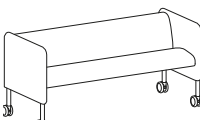
VIEW / ANSICHT	DIMENSIONS (in cm) / ABMESSUNGEN (in cm)			CATALOGUE NUMBER / PRODUKT-SYMBOL	NET PRICE in € / NETTOPREIS in €							
	WIDTH/ BREITE	DEPTH/ TIEFE	HEIGHT / HÖHE		upholstery / Polster							
					gr. 0	gr. A	gr. B	gr. C	gr. D	gr. E	gr. F	gr. G
	71	68	73	P4-801	835	872	998	1156	1332	1472	1611	1820
				P4-802	921	958	1083	1242	1418	1558	1697	1906

SOFAS

VIEW / ANSICHT	DIMENSIONS (in cm) / ABMESSUNGEN (in cm)			CATALOGUE NUMBER / PRODUKT-SYMBOL	NET PRICE in € / NETTOPREIS in €							
	WIDTH/ BREITE	DEPTH/ TIEFE	HEIGHT / HÖHE		upholstery / Polster							
					gr. 0	gr. A	gr. B	gr. C	gr. D	gr. E	gr. F	gr. G
	161	68	73	P4-803	1124	1193	1388	1634	1918	2141	2364	2703
				P4-804	1209	1279	1474	1720	2004	2226	2449	2789
	101	78	134	P4-805	1235	1324	1575	1890	2258	2546	2838	3270
				P4-806	1325	1413	1664	1980	2347	2635	2928	3360
	161	78	134	P4-807	1483	1599	1920	2324	2793	3169	3546	4108
				P4-808	1573	1689	2009	2414	2883	3259	3636	4197

PRICES / PREISE

SCREEN - CONNECTOR FOR HIGH SOFAS / SCREEN - VERBINDUNGSELEMENT FÜR HOHE SOFAS

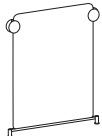
VIEW / ANSICHT	DIMENSIONS (in cm) / ABMESSUNGEN (in cm)			CATALOGUE NUMBER / PRODUKT- SYMBOL	NET PRICE in € / NETTOPREIS in €							
	WIDTH/ BREITE	DEPTH/ TIEFE	HEIGHT / HÖHE		upholstery / Polster							
					gr. 0	gr. A	gr. B	gr. C	gr. D	gr. E	gr. F	gr. G
	99	6	129/134	P4-809	478	515	599	701	822	919	1 017	1 166

POUFFES / SITZPUFFE

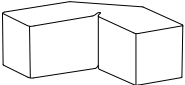
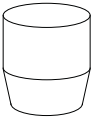
VIEW / ANSICHT	DIMENSIONS (in cm) / MASSE (in cm)			CATALOGUE NO. / KATA- LOG NR	NET PRICE IN EUR / NETTOPREIS in €							
	Width / B	Depth / T	Height / H		upholstery / Stoff							
					Gr. A	Gr. B	Gr. C	Gr. D	Gr. E	Gr. F	Gr. G	Gr. H
	100	100	43	P4-418	554	628	691	793	856	952	1 089	1 237
	36	36	43	P4-419	383	412	435	480	503	543	593	656

ROTATING TABLE / DREHBARE TISCH





VIEW / ANSICHT	DIMENSIONS (in cm) / ABMESSUNGEN (in cm)			CATALOGUE NUMBER / PRODUKT- SYMBOL	NET PRICE in € / NETTOPREIS in €				
	WIDTH/ BREITE	DEPTH/ TIEFE	HEIGHT / HÖHE		melamine / Melaminplatten	MDF lakier mat	natural veneer / Furnier		
							gr. 1	gr. 2	gr. 3
	45	28	40	P4-676	161	177	209	225	230

TABLE / TISCHE

VIEW / ANSICHT	DIMENSIONS (in cm) / ABMESSUNGEN (in cm)			CATALOGUE NUMBER / PRODUKT- SYMBOL	NET PRICE in € / NETTOPREIS in €			
	WIDTH/ BREITE	DEPTH/ TIEFE	HEIGHT / HÖHE		melamine / Melaminplatten	natural veneer / Furnier		
						gr. 1	gr. 2	gr. 3
	120	70	70	P4-130	640	757	801	831

PRICES / PREISE

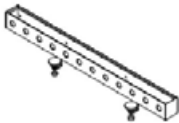
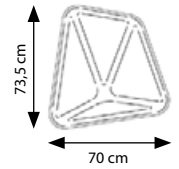
ACCESSORIES

VIEW / ANSICHT	DIMENSIONS (in cm) / MASSE (in cm)			CATA-LOGUE NO. / KATALOG NR.	NET PRICE IN EUR / NETTOPREIS in €		DESCRIPTION / BESCHREIBUNG	REMARKS / DETAILS
	Width / B	Depth / T	Height / H		Agava upholstery / Stoff Agava	Blazer upholstery / Stoff Blazer		
	120	10	28	P4-603	377	402	upper section rail, upholstered, front and rear magnetic function. Tray P4-613 can be placed on an upper moulding / Aufsatzschiene, gepolstert, Magnetfunktion an der Vorder- und Rückseite. An der oberen Leiste kann Tablett P4-613 angebracht werden.	fixed to the top / an der Tischplatte befestigt
 external view / Außenansicht  internal view / Innenansicht	70	1,2	73,5	P4-604	585	600	rotating screen left or right / Drehblende links oder rechts	-
	42	23	14	P4-605	99		footrest, covers black, frame powder painted / Fußbank, Abdeckung - Schwarz, Gestellfarbe zur Auswahl	-

DESK ACCESSORIES / SCHREIBTISCH

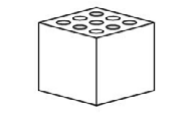
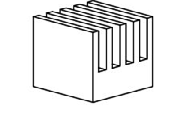
VIEW / ANSICHT	DIMENSIONS (in cm) / MASSE (in cm)			CATA-LOGUE NO. / KATALOG NR.	NET PRICE IN EUR / NETTOPREIS in €	REMARKS / DETAILS
	Width / B	Depth / T	Height / H			
	7	7	6	P4-614	17	desk accessories - wooden block for pens, raw wood, to be placed freely or in the tray P4-613 / Schreibtischzubehör: Stifthalter, Rohholz, alleinstehend bzw. für die Kleinschale P4-611
	7	7	6	P4-615	17	desk accessories - wooden block for pieces of paper, raw wood, to be placed freely or in the tray P4-613 / Schreibtischzubehör: Zettelkasten, Rohholz, alleinstehend bzw. für die Kleinschale P4-611