



**Modular locker cabinets /
Das modulare Schließfachsystem**

L2 Lockers / Lokers

Small storage lockers, providing a variety of alternative choices. Locker cabinets are units of small compartments locked with a key or combination lock, with an optional paper grommet. A practical solution to store personal belongings in offices, changing rooms or dining facilities. /

So kompakt die Fächer, so vielfältig die Möglichkeiten. Die Fächer des Schrankwandsystems Lokers sind mit herkömmlichem Schlüssel oder Codeschloss verschließbar und optional mit Einwurfschlitz erhältlich. Sie bieten eine praktische Lösung zur Aufbewahrung von persönlichen Gegenständen in Büros, Umkleide- oder Gemeinschaftsräumen.

COLLECTION ELEMENTS / ELEMENTE DER KOLLEKTION

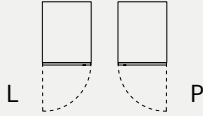
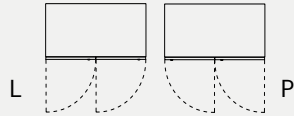
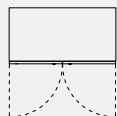
LOCKER CABINETS L2 / SCHLISSFACHSYSTEM L2						
BODY / KORPUS	melamine chipboard 18 mm, edging 2 mm / Melaminbeschichtete Spanplatte, Dicke 18 mm, geklebter Rand 2 mm					
FRONTS / FRONTEN	melamine chipboard 18 mm, edging 2 mm / Melaminbeschichtete Spanplatte, Dicke 18 mm, geklebter Rand 2 mm					
	hinges / Scharniere	110 degrees hinges, soft-close / Scharniere mit 110 grad öffnungswinkel, Soft-Close				
	grain layout / Maserung	Vertical / Vertikal				
	opening / Öffnung	Version 1	Version 2		Version 3	
		module width 1s / Modulbreite 1s	module width 2s / Modulbreite 2s			
	to the left or right / nach links oder rechts	to the right or left / nach rechts oder links		left part opens to the left, / linker Teil öffnet sich nach links, part of the right opens to the right / Ein Teil der rechten Seite öffnet sich nach rechts		
						
colours / Farbe	as part of one module, all doors are in the same colour, the body colour is selected separately, possibility of choosing each front separately for an additional charge / Als Teil eines Moduls haben alle Türen die gleiche Farbe, die Körperfarbe wird separat ausgewählt, Möglichkeit, jede Front einzeln gegen Aufpreis auszuwählen					
LOCK / SCHLOSS	Version 1 standard	Version 2 additional option / Optional gegen Aufpreis	Version 3 additional option / Optional gegen Aufpreis	Version 4 additional option / Optional gegen Aufpreis	Version 4 additional option / Optional gegen Aufpreis	Version 5 additional option / Optional gegen Aufpreis
	1-point lock, 2 keys in complete set / 1-Punkt-Verriegelung, 2 Schraubschlüssel inklusive	mechanical combination lock / mechanisches Zahlenschloss Kombinationsschloss A service key is required for installation. / Für die Installation ist ein Service-Schlüssel erforderlich.	electronic combination lock / elektronisches Zahlenschloss	electronic card lock / elektronisches Kartenschloss A minimum of 2 UN-194 cards are required for use. / Für den Gebrauch sind mindestens 2 UN-194-Karten erforderlich.	electronic fingerprint lock / elektronisches Schloss mit Fingerabdruck	other lock according to valuation / anderes Schloss nach Preisangabe
BASE / SOCKEL	skid base or bottom panel / Kufen oder Bodenplatte					
	2 base widths: / 2 Sockelbreiten:		1 S - for a single cabinet / 1 S - für Einzelschränke		2 S - for a double cabinet / 2 S - für Doppelschränke	
	level adjustment within 10mm / Regulierung im Bereich 10 mm					
ADDITIONS / ZUBEHÖR	paper grommet, assembled in upper part of door / Einwurfschlitz im oberen Teil der Tür		shelf inside cabinet, melamine board 18 mm thick / Regalboden, melaminbeschichtete Platte, Dicke 18mm		self-adhesive plastic label according to template dim. 4x4 cm / selbstklebendes Kunststoffetikett nach Vorlage Abm. 4x4 cm	
PACKAGING / VERPACKUNG	delivery as assembled unit / Anlieferung erfolgt montiert					

FINISHING / AUSFÜHRUNG

CABINETS / SCHRÄNKE

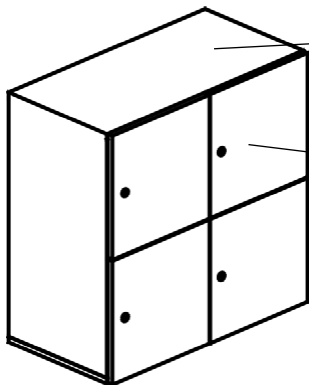

BODY / KORPUS

- melamine board / Melamine Platte

FRONTS / FRONTEN

- melamine board / Melamine Platte

BASES / SOCKEL

SKID BASE / KUFEN

- powder coated metal / Pulverbeschichtetes Metall

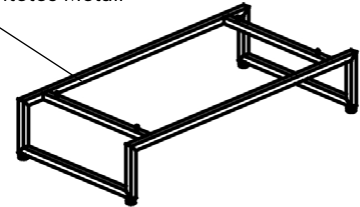

BOTTOM PANEL / BODENPLATTE

- melamine board / Melamine Platte

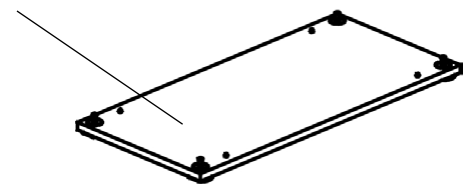

ADDITIONS / ZUBEHÖR

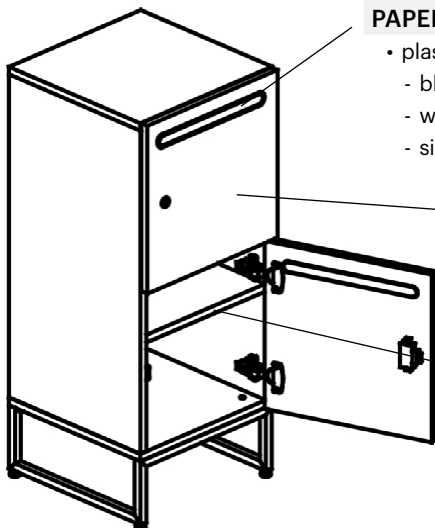

PAPER GROMMET / EINWURFSCHLITZ

- plastic: / Kunststoff:
 - black / schwarz
 - white / Weiß
 - silver / Silber

LABEL / ETIKETT

- plastic: / Kunststoff:
 - black / schwarz
 - white / Weiß

SHELF / REGALBODEN

- melamine board / Melamine Platte

AVAILABLE COLOURING / FARBEN

MELAMINE BOARD / MELAMINE PLATTE

- full colors according to the Balma pattern book / alle Farben aus dem Balma-Musterbuch

POWDER COATED METAL / PULVERBESCHICHTETES METALL

- full colors according to the Balma pattern book / alle Farben aus dem Balma-Musterbuch

ADDITIONAL CHARGE / AUFPREIS

MELAMINE BOARD / MELAMINE PLATTE

- additional payment for fronts in different colors / Aufpreis für Fronten in anderen Farben:
 - single / Einzeln + 25 EUR
 - double / Doppelt + 50 EUR

PRICES / PREISE

CABINETS WIDTH 1S / SCHRÄNKE 1S

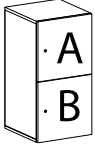
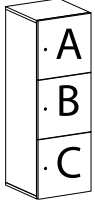
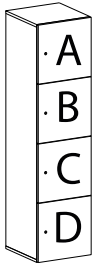
VIEW / ANSICHT	DIMENSIONS (IN CM) / ABMESSUNGEN (IN CM)			CATALOGUE NUMBER / PRODUKT-SYMBOL	NET PRICE in EUR / NETTOPREIS in €						
	width / breite	depth / tiefe	height / höhe		L2 standard	Additional charge / Aufpreis					
					1-point lock / 1-Punkt-Verriegelung	lock / Schloss			paper grommet / Einwurfschlitz	shelf / Regalboden	
						mechanical / mechanisches	electronic / elektronisches				
				combination	combination	card / Karte	fingerprint / Fingerabdruck				
	40	42	L2-11	166	26	66	71	73	15	15	
		52	L2-31	191							
	40	42	L2-12	239	52	132	142	146	30	30	
		52	L2-32	282							
	40	42	L2-13	342	78	198	213	219	45	45	
		52	L2-33	382							
	40	42	L2-14	376	104	264	284	292	60	60	
		52	L2-34	418							

PRICES / PREISE

2S WIDTH CABINETS BOTH OPENING TO THE RIGHT OR LEFT /
2S BREITE SCHRÄNKE - DIE SICH NACH RECHTS ODER LINKS ÖFFNEN SEITE



VIEW / ANSICHT	DIMENSIONS (IN CM) / ABMESSUNGEN (IN CM)			CATALOGUE NUMBER / PRODUKT- SYMBOL	NET PRICE in EUR / NETTOPREIS in €						
	width / breite	depth / tiefe	height / höhe		L2 standard	Additional charge / Aufpreis					
					1-point lock / 1-Punkt- -Verriegelung	lock / Schloss			paper grommet / Einwurf- schlitz	shelf / Regal- boden	
						mechanical / mechanisches	electronic / elektronisches				
		combination	combi- nation	card / Karte	finger- print / Finger- abdruck						
	42	40	80	L2-21	267	52	132	142	146	30	30
	52			L2-41	281						
	42	80	80	L2-22	419	104	264	284	292	60	60
	52			L2-42	437						
	42	120	80	L2-23	559	156	396	426	438	90	90
	52			L2-43	584						
	42	160	80	L2-24	697	208	528	568	584	120	120
	52			L2-44	717						

PRICES / PREISE

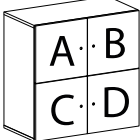
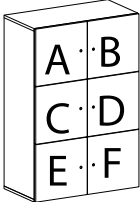
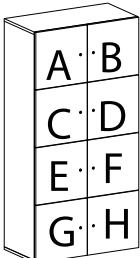



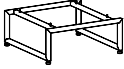

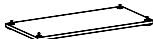



2S WIDTH CABINETS, OPENING TO THE RIGHT AND LEFT / 2S BREITE SCHRÄNKE, ÖFFNUNG NACH RECHTS UND LINKS

VIEW / ANSICHT	DIMENSIONS (IN CM) / ABMESSUNGEN (IN CM)			CATALOGUE NUMBER / PRODUKT-SYMBOL	NET PRICE in EUR / NETTOPREIS in €						
	width / breite	depth / tiefe	height / höhe		L2 standard	Additional charge / Aufpreis					
					1-point lock / 1-Punkt-Verriegelung	lock / Schloss			paper grommet / Einwurfschlitz	shelf / Regalboden	
						mechanical / mechanisches combination	electronic / elektronisches combination	card / Karte			fingerprint / Fingerabdruck
	42	40	40	L2-61	263	52	132	142	146	30	30
	52			L2-71	268						
	42	80	80	L2-62	415	104	264	284	292	60	60
	52			L2-72	432						
	42	120	120	L2-63	559	156	396	426	438	90	90
	52			L2-73	575						
	42	160	160	L2-64	701	208	528	568	584	120	120
	52			L2-74	707						

BASES FOR THE CABINETS / SOCKEL

VIEW / ANSICHT	DIMENSIONS (IN CM) / ABMESSUNGEN (IN CM)			CATALOGUE NUMBER / PRODUKT-SYMBOL	NET PRICE in EUR / NETTOPREIS in €
	width / breite	depth / tiefe	height / höhe		
	40	40	16,5	L2-51	99
		50		L2-55	116
	80	40	16,5	L2-52	106
		50		L2-56	121
	36	36	2,5	L2-53	47
		46		L2-57	51
	76	36	2,5	L2-54	53
		46		L2-58	58

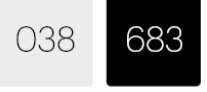
PRICES / PREISE

OPTIONAL COMPONENTS / OPTIONALE KOMPONENTEN						
VIEW / ANSICHT	DIMENSIONS (IN CM) / ABMESSUNGEN (IN CM)			CATALOGUE NUMBER / PRODUKT-SYMBOL	NET PRICE in EUR / NETTOPREIS in €	REMARKS / BEMERKUNGEN
	width / breite	depth / tiefe	height / höhe			
	8	-	3	UN-182	26	combination lock left / Kombinationsschloss Links
				UN-183	26	combination lock right / Kombinationsschloss Rechts
				UN-188	40	service key for code lock / serviceschlüssel zu Codesschloss
	4,5	4,5	2,3	UN-191	66	electronic combination lock / elektronisches Zahlenschloss
				UN-192	73	electronic fingerprint lock / elektronisches Schloss mit Fingerabdruck
				UN-193	71	electronic card lock / elektronisches Kartenschloss
	8,6	5,4	0,84	UN-194	6	lock card for UN-193 / Karte für Schloss UN-193
	33	3,4	3,4	UN-184	15	paper grommet / Einwurfschlitz
	4	-	4	UN-155	3	label / Etikett
	36	38	1,8	L2-150	15	shelf for 1S cabinet, depth 42cm
		48		L2-151	15	shelf for 1S cabinet, depth 52cm
		38		L2-152	15	shelf for 2S cabinet, depth 42cm
		48		L2-153	15	shelf for 2S cabinet, depth 52cm