



## Cabinets / Schränke

### J\_system

The complex J cabinet system constitutes a comprehensive solution for storing documents in the office. The abundance of accessories ensures full comfort of usage and functionality to meet individual needs. The system consists of cabinets, file cabinets, wardrobes, corner cabinets and corner bookshelves. The cabinets can be equipped with board shelves, metal shelves with briefcase hangers, file frames, drawers and slide-out shelves. Available door options: solid hinged, glass, sliding, jalousie (horizontal and vertical). Available widths: 40, 60, 80, 100, 120 and 160 cm. Heights sufficient for two to six file binders. Metal, powder painted cabinet pedestals feature height adjustment. Optional pedestal board slats.

Das ausgebaute weiterentwickelte Schranksystem J ist ein kompaktes Lösungsangebot, wenn es um die Büroorganisation und die Unterbringung von Hängeregistraturmaterial geht. Die reichhaltige Ausstattung der Schränke gewährleistet höchsten Komfort in der Benutzung und ermöglicht die Anpassung an sämtliche individuelle Funktionalitätsanforderungen. In das Set werden Hängeregistraturschränke, Karteikartenschränke, Garderobenschränke sowie Eckschränke und Regale eingeführt. Die Schränke können wahlweise mit Einlegeböden aus Melaminplatten, Metallböden zum Einhängen von Hängemappen, Hängeregistratur, Schubladen oder herausziehbaren Einlegeböden ausgestattet werden.

**COLLECTION ELEMENTS / ELEMENTE DER KOLLEKTION**

CABINETS / SCHRÄNKE	
BODY / KORPUS	18mm melamine / Melaminplatte 18mm, 2 mm edge / 2 mm Kanten, BACK WALL / Rückwand 18mm assembly with cam fixings / Montage mit Exzenter-Schraube
TOP PLATE, BOTTOM PLATE / ABDECKPLATTE, SOCKEL	18mm melamine / Melaminplatte 18 mm
BOTTOM RING / SOCKEL	<div style="display: flex; justify-content: space-between;"> <div style="width: 45%;"> <p>version 1 made of metal, powder painted, level adjusting (20 mm range) in four or six points (depending on the width) / Metall, pulverbeschichtet, Bodenausgleich 20 mm in vier oder sechs Punkten</p> </div> <div style="width: 45%;"> <p>version 2 feet with levelling in range 10mm, height 27 mm. Additional payment 10 EUR per cabinet / Füße mit Nivellierung im Bereich 10 mm, Höhe 27 mm. Zuzahlung 10 EUR pro Schrank</p>  </div> </div>
NOTE / WICHTIG!	BOTTOM RING SHOULD BE ORDERED SEPARATELY! / SOCKEL - separat bestellen !
BOTTOM SLAT / SOCKELLEISTE	optional cover on the metal bottom ring, made of 18mm melamine chipboard (MFC), NOT available in corner bookcases and cabinets / Zusätzliche Sockelleiste auf den Metallsockel in 18mm Melaminplatte, NICHT für Eckregale-bzw. schränke erhältlich
DOOR / TÜR	<div style="display: flex; justify-content: space-between;"> <div style="width: 30%;"> <p>Version 1 MELAMINE chipboard (MFC) / MELAMINPLATTE 18 mm, 2 mm edge / 2 mm Kanten</p> </div> <div style="width: 35%;"> <p>Version 2 TAMBOUR / ROLLADE (PVC) vertical / Vertikal aluminium runners put on the front of the body; aluminium, silver closing slot; drum jalousie system lowers the working space by 1/2 file height / Silber Aluminiumführungen der Rollade im vorderen Bereich am Korpus befestigt ; Aluminiumschlosseleiste;</p> </div> <div style="width: 30%;"> <p>Version 3 TAMBOUR / ROLLADE (PVC) horizontal runners put into the body, worm jalousie system at the side, diminishes the width of the cabinet by 20 cm, and in case of 160 cm wide – 40 cm / Führungen in Korpus eingetaucht</p> </div> </div>
HINGES / (TÜR-)ANGEL	<div style="display: flex; justify-content: space-between;"> <div style="width: 45%;"> <p>version 1 standard: 110° soft close</p> </div> <div style="width: 45%;"> <p>version 2 270° - additional charge / Aufpreis</p> </div> </div>
DOOR STOPPER / TÜRSTOPPER	optional door stopper "softclose", fixed to the top ring inside the cabinet with 270° hinges, at the same side as the hinges / optional Türstopper "softclose an der Abdeckplatte mit 270° Scharnieren
SHELVES / FACHBÖDEN	<div style="display: flex; justify-content: space-between;"> <div style="width: 45%;"> <p>Version 1 melamine / Melaminplatte 25mm melamine / Melaminplatte, all BALMA colours / alle Farben laut BALMA Mustermappe</p> <p>according to norm PN-EN 14073-3:2006 the maximum load in cabinet 09J15 is 45 kg / bei dem Schrank 09J15 maximale Belastung von 45kg (Norm PN-EN 14073-3:2006)</p> </div> <div style="width: 45%;"> <p>Version 2 metal, powder painted, file suspension function / Metall; pulverbeschichtet, Hängemappen</p> <p>according to norm PN-EN 14073-3:2006 the maximum load in cabinet 09J25 is 69 kg / bei dem Schrank 09J25 maximale Belastung von 69kg (Norm PN-EN 14073-3:2006)</p> </div> </div> <p>block system – shelf fixed, blocked from sliding; level adjusting in range 32mm / Ausziehsperre – Bodenausgleich 32mm</p> <p>IMPORTANT: metal shelves are standard for cabinets wider than 80 cm, the widths of shelves in side opening jalousie cabinets (08J) are different than the width of the cabinets. / WICHTIG: Metalleinlegeböden gehören zum Standardprogramm mehr als 80cm-Breite. Einlegebödenbreite bei den Rolladenschränken (08J) unterscheidet sich von der Schrankbreite</p>
HANDLES / GRIFFE	<div style="display: flex; justify-content: space-between;"> <div style="width: 30%;"> <p>Version 1 melamine board doors and shutters, square handle, 128 mm, nickel-plated or powder-coated metal / Türen und Fensterläden aus Melaminplatten, quadratischer Griff, 128 mm, Metall vernickelt oder pulverbeschichtet</p> </div> <div style="width: 35%;"> <p>Version 2 2 points, L-shaped, 128mm, with key (1 bending key and 1 standard) / 2 Punkt in Form eines L, 128 mm, mit Schloss (1xKlappschlüssel und 1 Standard Schlüssel) - additional charge / Aufpreis</p> </div> <div style="width: 30%;"> <p>Version 3 other handle according to handles' pricelist / oder andere Griffe vom Standardprogramm (Accessoires)</p> </div> </div>
LOCKS / SCHLUSS	3 point-lock for 3 OH cabinets and higher, up to 2OH – one point lock / Drehverschluss ab 3OH, bei den 2OH Schränken ein Punktverschluss
HANGING FILE FRAME / HÄNGENDER AKTENRAHMEN	the possibility of mounting the file frame in the cabinet when mounting 2 or 3 file frames, it is necessary to install a slide lock / die Möglichkeit, den Aktenrahmen im Schrank zu montieren; Bei der Montage von 2 oder 3 Orderrahmen ist die Installation des Verlängerungsschlusses erforderlich
SYMBOL	<p>10: 1 means MFC shelves, 0 means no frame for suspension files / 10:1 bedeutet Melaminböden, 0 steht für kein Hängeregistratur</p> <p>12: 1 means MFC shelves, 2 means 2 frames for suspension files / 12:1 bedeutet Melaminböden, 2 steht für 2 Stck. Hängeregistratur</p> <p>13: 1 means MFC shelves, 3 means 3 frames for suspension files / 13:1 bedeutet Melaminböden, 3 steht für 3 Stck. Hängeregistratur</p> <p>20: 2 means metal shelves, 0 means no frame for suspension files / 20:2 bedeutet Metallböden, 0 steht für kein Hängeregistratur</p> <p>22: 2 means metal shelves, 2 means 2 frames for suspension files / 22:2 bedeutet Metallböden, 2 steht für 2 Stck. Hängeregistratur</p> <p>23: 2 means metal shelves, 3 means 3 frames for suspension files / 23:2 bedeutet Metallböden, 3 steht für 3 Stck. Hängeregistratur</p>
NOTE / WICHTIG	when ordering a cabinet please add the above symbol, for example: 06J06_12 for a cabinet with MFC shelves and 2 frames for suspension files / bei der Bestellung bitte folgende Beschreibung angeben: z. B. 06J06_12 für einen Schrank mit Melaminböden und 2 Stck. Hängeregistratur

**FINISHING / AUSFÜHRUNG**

**CABINETS / SCHRÄNKE**

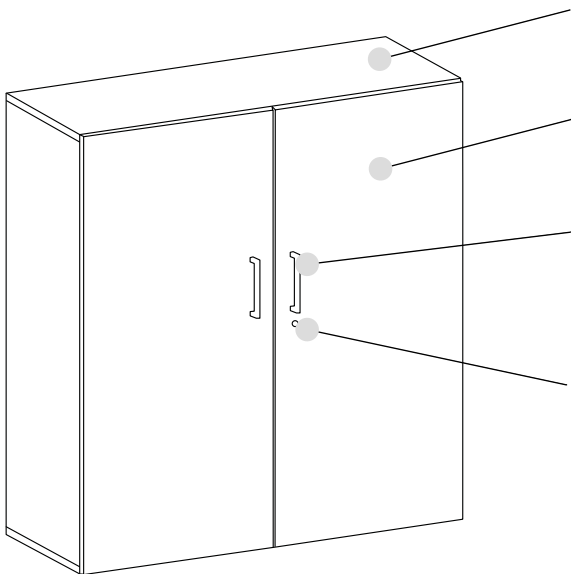

**BODY / KORPUS**

- melamine board / Melamine Platte

**DOOR / TÜR**

- melamine board / Melamine Platte

**HANDLES / GRIFFE**

- square handle / quadratischer Griff,
- nickel-plated / Metall vernickelt
- powder coated metal / pulverbeschichtet Metall

**LOCK / VERSCHLUSS**

- lock separately / Schloss

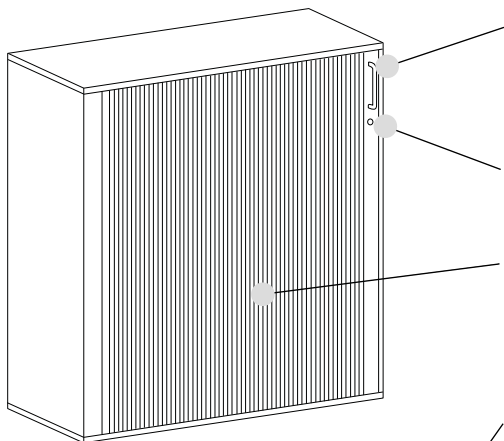

**HANDLES / GRIFFE**

- square handle / quadratischer Griff,
- nickel-plated / Metall vernickelt
- powder coated metal / pulverbeschichtet Metall

**LOCK / VERSCHLUSS**

- lock separately / Schloss

**TAMBOUR / ROLLADE**

- plastic / Kunststoff

**BOTTOM RING / SOCKEL**

- powder coated metal / Pulverbeschichtetes Metall

**BOTTOM SLAT / SOCKELLEISTE**

- melamine board / Melamine Platte

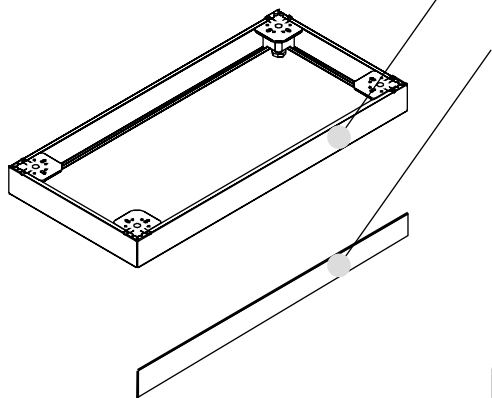

**FEET / FÜSSE**

- plastic / Kunststoff



<b>AVAILABLE COLOURING / FARBEN</b>
-------------------------------------

**MELAMINE BOARD / MELAMINE PLATTE**

- full colors according to the Balma pattern book /  
alle Farben aus dem Balma-Musterbuch

**TAMBOUR / ROLLADE**

- silver / Silber
- grey / Grau
- black / Schwarz
- white / Weiß
- graphite / Graphit

**POWDER COATED METAL / PULVERBESCHICHTETES METALL****PLINTH AND SHELVES / SOCKEL UND FACHBÖDEN**

- silver glossy / Silberglanz
- RAL 9016 white satin / Weiß Satin
- RAL 9016 white matt / Weiß Matt
- RAL 7037 deep grey / Tiefes Grau
- RAL 7021 dark graphite / Intensives Grafit
- Sand
- RAL 9005 black matt / Schwarz Matt
- RAL 9005 black satin / Schwarz Satin
- light grey / Lichtgrau
- RAL 706050 ocher / Ocker
- RAL 404040 sienna / Siena
- true grey / Echtes Grau
- mint / Minze

other colors from the Balma pattern book available at  
an additional charge / gegen Aufpreis weitere Farben  
aus dem Balma-Musterbuch

**HANDLES / GRIFFE**

- RAL 9016 white satin / Weiß Satin
- light grey / Lichtgrau
- RAL 7037 deep grey / Tiefes Grau
- RAL 9005 black matt / Schwarz Matt

other colors from the Balma pattern book available at  
an additional charge / gegen Aufpreis weitere Farben  
aus dem Balma-Musterbuch

**PRICES / PREISE**

<p><b>POWDER COATED METAL / PULVERBESCHICHTETES METALL</b></p> <p><b>PLINTH AND SHELVES / SOCKEL UND FACHBÖDEN</b></p> <ul style="list-style-type: none"> <li>- RAL 3005 Burgund</li> <li>- RAL 6004 Tropic</li> <li>- RAL 8023 Corten</li> <li>- RAL 5003 ocean / Ozean</li> <li>• shelves / Fachboden                   + 14 EUR per pcs / pro Stück</li> <li>• plinth / Sockel                           + 28 EUR per pcs / pro Stück</li> </ul>	<p><b>HANDLES / GRIFFE</b></p> <ul style="list-style-type: none"> <li>- silver glossy / Silberglanz</li> <li>- RAL 9016 white matt / Weiß Matt</li> <li>- RAL 9005 black satin / Schwarz Satin</li> <li>- true grey / Echtes Grau</li> <li>- RAL 7021 dark graphite / Intensives Grafit</li> <li>- mint / Minze</li> <li>- sand / Sand</li> <li>- RAL 3005 Burgund</li> <li>- RAL 6004 Tropic</li> <li>- RAL 8023 corten</li> <li>- RAL 5003 ocean / Ozean</li> <li>- RAL 706050 ocher / Ocker</li> <li>- RAL 404040 sienna / Siena</li> <li>• handles / Griffe                       + 3 EUR per pcs / pro Stück</li> </ul>
---	--



		NET PRICE in EUR / NETTOPREIS in €		REMARKS / BEMERKUNGEN
		FRONT		
		single-door / eintüriger	double-door / zweytüriger	
1	handle L-shaped with lock / Griff in L-Form mit Schloss	50	99	
2	270° hinges / Scharniere 270°	18	37	2OH
		18	37	3OH
		27	55	4OH
		27	55	5OH
		37	73	6OH
3	feet with levelling / Füße mit Nivellierung	10		per cabinet / pro Schrank

**PRICES / PREISE**

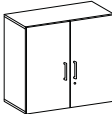
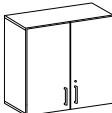

**CABINETS WITH DOORS – GROUP 06J / AKTENSCHRANKE – GRUPPE 06J**  
**2OH**

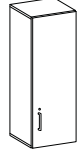
VIEW / ANSICHT	DIMENSIONS (in cm) / ABMESSUNGEN (in cm)			CATALOGUE NUMBER / PRODUKT-SYMBOL	NET PRICE in EUR / NETTOPREIS in €	
	WIDTH / BREITE	DEPTH / TIEFE	HEIGHT / HÖHE		10 mfc shelves / Melaminböden	20 metal shelves / Metallböden
	40,1	46,1	71,5	<b>06J01</b>	231	242
	60,1			<b>06J06</b>	258	271
	80,1	46,1	71,5	<b>06J11</b>	342	360
	100,1			<b>06J73</b>	-	397
	120,1			<b>06J74</b>	-	434
	80,1	46	71,5	<b>06J75</b>	342	360
	100,1			<b>06J76</b>	-	397
	120,1			<b>06J77</b>	-	434

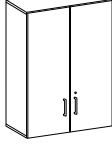

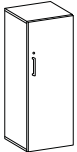

**3 OH**

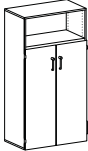
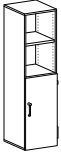
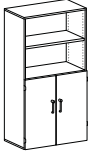
VIEW / ANSICHT	DIMENSIONS (in cm) / ABMESSUNGEN (in cm)			CATALOGUE NUMBER / PRODUKT-SYMBOL	NET PRICE in EUR / NETTOPREIS in €	
	WIDTH / BREITE	DEPTH / TIEFE	HEIGHT / HÖHE		10 MFC shelves / Melaminböden	20 metal shelves / Metallböden
	40,1	46,1	106,7	<b>06J02</b>	293	313
	60,1			<b>06J07</b>	336	366
	40,1	46,1	106,7	<b>06J66</b>	293	313
	60,1			<b>06J70</b>	336	366
	80,1	46,1	106,7	<b>06J12</b>	424	457
	100,1			<b>06J16</b>	-	500
	120,1			<b>06J20</b>	-	554
	80,1	46,1	106,7	<b>06J67</b>	424	457
	100,1			<b>06J71</b>	-	500
	120,1			<b>06J72</b>	-	554

**PRICES / PREISE**

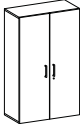
4 OH						
VIEW / ANSICHT	DIMENSIONS (in cm) / ABMESSUNGEN (in cm)			CATALOGUE NUMBER / PRODUKT- SYMBOL	NET PRICE in EUR / NETTOPREIS in €	
	WIDTH / BREITE	DEPTH / TIEFE	HEIGHT / HÖHE		10 MFC shelves / Melaminböden	20 metal shelves / Metallböden
	40,1	46,1	143	<b>06J03</b>	369	404
	60,1			<b>06J08</b>	412	455
	80,1	46,1	143	<b>06J13</b>	557	605
	100,1			<b>06J17</b>	-	651
	120,1			<b>06J21</b>	-	721
	40,1	46,1	143	<b>06J24</b>	331	355
	60,1			<b>06J27</b>	369	399
	80,1	46,1	143	<b>06J30</b>	490	523
	100,1			<b>06J33</b>	-	559
	40,1	46,1	143	<b>06J40</b>	317	335
	60,1			<b>06J43</b>	355	381
	80,1	46,1	143	<b>06J46</b>	456	487
	100,1			<b>06J49</b>	-	526

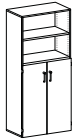
**PRICES / PREISE**

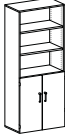
5OH						
VIEW / ANSICHT	DIMENSIONS (in cm) / ABMESSUNGEN (in cm)			CATALOGUE NUMBER / PRODUKT- SYMBOL	NET PRICE in EUR / NETTOPREIS in €	
	WIDTH / BREITE	DEPTH / TIEFE	HEIGHT / HÖHE		10 MFC shelves / Melaminböden	20 metal shelves / Metallböden
	40,1	46,1	178,2	<b>06J04</b>	431	471
	60,1			<b>06J09</b>	457	518
	80,1	46,1	178,2	<b>06J14</b>	641	705
	100,1			<b>06J18</b>	-	763
	120,1			<b>06J22</b>	-	821
	40,1	46,1	178,2	<b>06J25</b>	373	407
	60,1			<b>06J28</b>	418	462
	80,1	46,1	178,2	<b>06J31</b>	543	588
	100,1			<b>06J34</b>	-	644
	40,1	46,1	178,2	<b>06J41</b>	357	390
	60,1			<b>06J44</b>	399	441
	80,1	46,1	178,2	<b>06J47</b>	518	565
	100,1			<b>06J50</b>	-	614

**PRICES / PREISE**

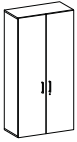
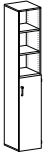
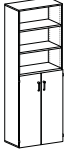
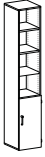
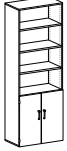
60H						
VIEW / ANSICHT	DIMENSIONS (in cm) / ABMESSUNGEN (in cm)			CATALOGUE NUMBER / PRODUKT- SYMBOL	NET PRICE in EUR / NETTOPREIS in €	
	WIDTH / BREITE	DEPTH / TIEFE	HEIGHT / HÖHE		10 MFC shelves / Melaminböden	20 metal shelves / Metallböden
	40,1	46,1	213,4	<b>06J05</b>	485	538
	60,1			<b>06J10</b>	560	628
	80,1	46,1	213,4	<b>06J15</b>	762	841
	100,1			<b>06J19</b>	-	910
	120,1			<b>06J23</b>	-	1012
	40,1	46,1	213,4	<b>06J26</b>	406	449
	60,1			<b>06J29</b>	466	523
	80,1	46,1	213,4	<b>06J32</b>	599	663
	100,1			<b>06J35</b>	-	725
	40,1	46,1	213,4	<b>06J42</b>	382	424
	60,1			<b>06J45</b>	444	501
	80,1	46,1	213,4	<b>06J48</b>	573	635
	100,1			<b>06J51</b>	-	697

**PRICES / PREISE**

**CABINETS WITH SLIDING DOORS – GROUP 07J / SCHIEBETÜRENSCHRÄNKE – GRUPPE 07J**  
**2 OH**

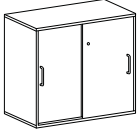
VIEW / ANSICHT	DIMENSIONS (in cm) / ABMESSUNGEN (in cm)			CATALOGUE NUMBER / PRODUKT-SYMBOL	NET PRICE in EUR / NETTOPREIS in €		
	WIDTH / BREITE	DEPTH / TIEFE	HEIGHT / HÖHE		10 MFC shelves / Melaminböden	20 metal shelves / Metallböden	REMARKS / BEMERKUNGEN
	80,1	44,1	71,5	<b>07J01</b>	284	301	
	100,1			<b>07J04</b>	323	336	vertical wall / Mittelwand
	120,1			<b>07J07</b>	342	372	vertical wall / Mittelwand
	160,1			<b>07J10</b>	437	485	vertical wall / Mittelwand

**3 OH**

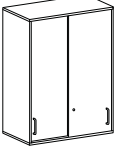
	80,1	44,1	106,7	<b>07J02</b>	357	393	
	100,1			<b>07J05</b>	401	435	vertical wall / Mittelwand
	120,1			<b>07J08</b>	435	490	vertical wall / Mittelwand
	160,1			<b>07J11</b>	554	635	vertical wall / Mittelwand
	80,1	44,1	106,7	<b>07J14</b>	357	393	
	100,1			<b>07J15</b>	401	435	vertical wall / Mittelwand

**4OH**

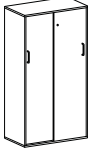
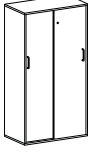
	80,1	44,1	143	<b>07J03</b>	435	487	
	100,1			<b>07J06</b>	475	538	vertical wall / Mittelwand
	120,1			<b>07J09</b>	521	611	vertical wall / Mittelwand
	160,1			<b>07J12</b>	649	764	vertical wall / Mittelwand
	80,1	44,1	143	<b>07J13</b>	460	-	

**PRICES / PREISE**

**CABINETS WITH JALOUSIE DOORS – GROUP 08J / ROLLADENSCHRÄNKE – GRUPPE 08J**  
2 OH

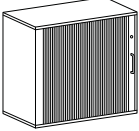
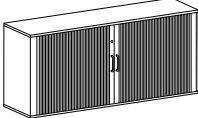
VIEW / ANSICHT	DIMENSIONS (in cm) / ABMESSUNGEN (in cm)			CATALOGUE NUMBER / PRODUKT-SYMBOL	NET PRICE in EUR / NETTOPREIS in €	
	WIDTH / BREITE	DEPTH / TIEFE	HEIGHT / HÖHE		10 MFC shelves / melaminböden	20 metal shelves / metallböden
	80,1	44,1	71,5	<b>08J01</b>	368	386
	100,1			<b>08J04</b>	434	453
	120,1			<b>08J07</b>	-	475
	160,1	44,1	71,5	<b>08J10</b>	-	692

3 OH

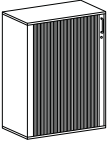
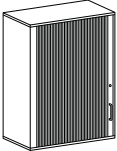
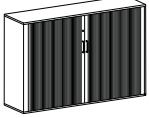
	80,1	44,1	106,7	<b>08J02</b>	519	554
	100,1			<b>08J05</b>	581	623
	120,1			<b>08J08</b>	-	705
	80,1	44,1	106,7	<b>08J22</b>	519	554
	100,1			<b>08J23</b>	581	623
	160,1	44,1	106,7	<b>08J11</b>	-	958

**PRICES / PREISE**

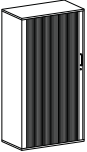
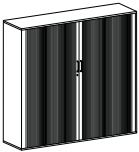
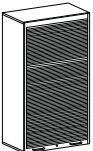
4 OH						
VIEW / ANSICHT	DIMENSIONS (in cm) / ABMESSUNGEN (in cm)			CATALOGUE NUMBER / PRODUKT-SYMBOL	NET PRICE in EUR / NETTOPREIS in €	
	WIDTH / BREITE	DEPTH / TIEFE	HEIGHT / HÖHE		10 MFC shelves / melaminböden	20 metal shelves / metallböden
	80,1	44,1	143	<b>08J03</b>	624	678
	100,1			<b>08J06</b>	740	800
	120,1			<b>08J09</b>	-	880
	160,1	44,1	143	<b>08J12</b>	-	1 214
	80,1	46	143	<b>08J13</b>	1 101	1 160
	100,1			<b>08J16</b>	-	1 337
	120,1			<b>08J19</b>	-	1 450

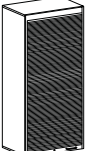
5 OH						
	80,1	46	178,2	<b>08J14</b>	1 209	1 292
	100,1			<b>08J17</b>	-	1 500
	120,1			<b>08J20</b>	-	1 639

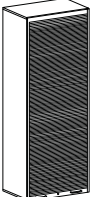
6 OH						
	80,1	46	213,4	<b>08J15</b>	1 301	1 394
	100,1			<b>08J18</b>	-	1 616
	120,1			<b>08J21</b>	-	1 865

**PRICES / PREISE**

BOOKSHELVES – GROUP 09J / OFFENE REGALE – GRUPPE 09J

2OH

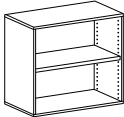
VIEW / ANSICHT	DIMENSIONS (in cm) / ABMESSUNGEN (in cm)			CATALOGUE NUMBER / PRODUKT-SYMBOL	NET PRICE in EUR / NETTOPREIS in €	
	WIDTH / BREITE	DEPTH / TIEFE	HEIGHT / HÖHE		10 MFC SHELVES / MELAMINBÖDEN	20 METAL SHELVES / METALLBÖDEN
	40,1	44,1	71,5	09J01	114	125
	60,1			09J06	137	150
	80,1			09J11	158	173
	100,1			09J16	-	201
	120,1			09J21	-	225

3OH

	40,1	44,1	106,7	09J02	150	170
	60,1			09J07	182	209
	80,1			09J12	214	247
	100,1			09J17	-	293
	120,1			09J22	-	327

4OH

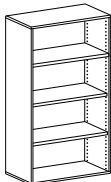
	40,1	44,1	143	09J03	196	229
	60,1			09J08	239	281
	80,1			09J13	280	327
	100,1			09J18	-	385
	120,1			09J23	-	435

5OH

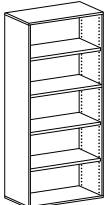
	40,1	44,1	178,2	09J04	242	282
	60,1			09J09	290	345
	80,1			09J14	337	402
	100,1			09J19	-	470
	120,1			09J24	-	531

6OH

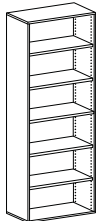

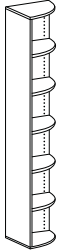

	40,1	44,1	213,4	09J05	275	329
	60,1			09J10	320	393
	80,1			09J15	395	473
	100,1			09J20	-	565
	120,1			09J25	-	637

**PRICES / PREISE**

**CORNER BOOKSHELVES: GROUP 09J / ECKREGALE: GRUPPE 09J**

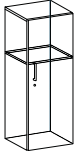



VIEW / ANSICHT	DIMENSIONS (in cm) / ABMESSUNGEN (in cm)			CATALOGUE NUMBER / PRODUKT-SYMBOL	NET PRICE in EUR / NETTOPREIS in €	REMARKS / BEMERKUNGEN
	WIDTH / BREITE	DEPTH / TIEFE	HEIGHT / HÖHE		10 MFC SHELVES / MELAMINBÖDEN	
	44,1	44,1	71,5	09J26	126	2OH
	44,1	44,1	106,7	09J27	162	3OH
	44,1	44,1	143	09J28	207	4OH
	44,1	44,1	178,2	09J29	250	5OH
	44,1	44,1	213,4	09J30	297	6OH

**WARDROBES 4OH / GARDEROBEN 4OH**

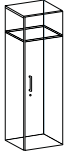

VIEW / ANSICHT	DIMENSIONS (in cm) / ABMESSUNGEN (in cm)			CATALOGUE NUMBER / PRODUKT-SYMBOL	NET PRICE in EUR / NETTOPREIS in €	REMARKS / BEMERKUNGEN		
	WIDTH / BREITE	DEPTH / TIEFE	HEIGHT / HÖHE		10 MFC SHELVES / MELAMINBÖDEN			
	40,1	46,1	143	09J41	360	hook for hanging clothes / Garderobenhacken		
	80,1			09J44	551	sliding rail for hanging clothes / Garderobenstange ausziehbar		
	100,1			09J47	614			
	120,1			09J50	677			
	120,1			09J53	666	sliding rail for hanging clothes, no shelves / Garderobenstange ausziehbar ohne Boden		
	80,1			60,1	143	09J56	554	fixed rail for hanging clothes, no shelves / Garderobenstange, ohne Boden
	100,1					09J59	620	
	120,1					09J62	679	

**PRICES / PREISE**

**WARDROBES 50H / GARDEROBEN 50H**



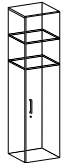

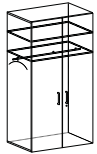
VIEW / ANSICHT	DIMENSIONS (in cm) / ABMESSUNGEN (in cm)			CATALOGUE NUMBER / PRODUKT-SYMBOL	NET PRICE in EUR / NETTOPREIS in €	REMARKS / BEMERKUNGEN
	WIDTH / BREITE	DEPTH / TIEFE	HEIGHT / HÖHE		10 MFC shelves / Melaminböden	
	40,1	46,1	178,2	09J42	398	hook for hanging clothes / Garderobenhacken
	80,1	46,1	178,2	09J45	633	sliding rail for hanging clothes / Garderobenstange ausziehbar
	100,1			09J48	711	
	120,1			09J51	788	
	120,1	46,1	178,2	09J54	772	
	80,1	60,1	178,2	09J57	657	fixed rail for hanging clothes / Garderobenstange
	100,1			09J60	736	
	120,1			09J63	804	

**WARDROBES 60H / GARDEROBEN 60H**

	40,1	46,1	213,4	09J43	490	hook for hanging clothes / Garderobenhacken
	80,1	46,1	213,4	09J46	750	sliding rail for hanging clothes / Garderobenstange ausziehbar
	100,1			09J49	844	
	120,1			09J52	930	
	120,1	46,1	213,4	09J55	910	sliding rail for hanging clothes, metal shelves/ Garderobenstange ausziehbar, Metallboden
	80,1	60,1	213,4	09J58	746	fixed rail for hanging clothes / Garderobenstange
	100,1			09J61	878	
	120,1			09J64	971	

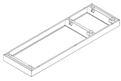
**PRICES / PREISE**

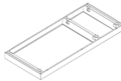
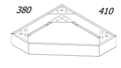
**METAL BOTTOM RINGS / METALLSOCKEL**

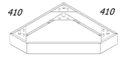
VIEW / ANSICHT	DIMENSIONS (in cm) / ABMESSUNGEN (in cm)			CATALOGUE NUMBER / PRODUKT-SYMBOL	NET PRICE in EUR / NETTOPREIS in €	REMARKS / BEMERKUNGEN			
	WIDTH / BREITE	DEPTH / TIEFE	HEIGHT / HÖHE						
	40	38	7	14J01	64	bottom rings for corner bookshelves / Metallsockel für Eckregale			
	60			14J02	74				
	80			14J03	78				
	100			14J04	87				
	120	38		14J05	101				
	160			14J06	106				
	80	52		14J07	87				
	100			14J08	90				
	120	52		14J13	99				
	38	41		14J09	82			right / Rechts	
	41	38		14J10	82			left / Links	
	41	41	14J11	87	middle / Mittel				

**BOTTOM SLATS / SOCKELVERKLEIDUNG/BODENLEISTEN**



VIEW / ANSICHT	DIMENSIONS (in cm) / ABMESSUNGEN (in cm)		CATALOGUE NUMBER / PRODUKT-SYMBOL	NET PRICE in EUR / NETTOPREIS in €	REMARKS / BEMERKUNGEN	
	WIDTH / BREITE	DEPTH / TIEFE				
	40	-	14J40	24	not available for corner bookcases / Für Eckregale nicht erhältlich	
	60	-	14J41	24		
	80	-	14J42	33		
	100	-	14J43	30		
	120	-	14J44	33		
	160	-	14J45	35		

**PRICES / PREISE**

**SLIDING FRAMES FOR SUSPENSION FILES / HERAUSZIEHBARE RAHMEN FÜR HÄNGEMAPPEN**

VIEW / ANSICHT	DIMENSIONS (in cm) / ABMESSUNGEN (in cm)		CATALOGUE NUMBER / PRODUKT-SYMBOL	NET PRICE in EUR / NETTOPREIS in €	
	WIDTH / BREITE	DEPTH / TIEFE		file frame ordered separately / Rahmen für Hängemappen separat bestellt	file frame ordered with a cabinet / Rahmen für Hängemappen bestellt mit einem Schrank
	60	-	<b>14J46</b>	206	185
	80	-	<b>14J47</b>	216	195
	100	-	<b>14J48</b>	222	200

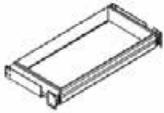
**METAL DRAWERS / METALLSCHUBLADEN**

VIEW / ANSICHT	DIMENSIONS (in cm) / ABMESSUNGEN (in cm)		CATALOGUE NUMBER / PRODUKT-SYMBOL	NET PRICE in EUR / NETTOPREIS in €	
	WIDTH / BREITE	DEPTH / TIEFE		file frame ordered separately / Rahmen für Hängemappen separat bestellt	
	80		<b>14J51</b>	231	
			<b>14J54</b>	13	divider to share space in the drawer / Trennelement

**BLOCKADES PREVENTING FROM PULLING OUT MORE THAN ONE DRAWER / AUSZUGSSPERREN FÜR MEHR ALS EINE SCHUBLADE**

VIEW / ANSICHT	DIMENSIONS (in cm) / ABMESSUNGEN (in cm)		CATALOGUE NUMBER / PRODUKT-SYMBOL	NET PRICE in EUR / NETTOPREIS in €		
	WIDTH / BREITE	DEPTH / TIEFE		blockades ordered separately / Auszugssperren separat bestellt	blockades ordered with a cabinet/ Auszugssperren bestellt mit einem Schrank	
			<b>14J66</b>	74	67	for 2 pcs set of sliding frames and metal drawers / für 2 stck. Hängeregistratur und Metallschubladen
			<b>14J67</b>	80	71	for 3 pcs set of sliding frames and metal drawers / für 3 stck. Hängeregistratur und Metallschubladen

**PRICES / PREISE**

**SLIDING SHELVES / HERAUSZIEHBARE EINLEGEBOEDEN**

VIEW / ANSICHT	DIMENSIONS (in cm) / ABMESSUNGEN (in cm)		CATALOGUE NUMBER / PRODUKT-SYMBOL	NET PRICE in EUR / NETTOPREIS in €	REMARKS / BEMERKUNGEN
	WIDTH / BREITE	DEPTH / TIEFE			
	40		<b>14J60</b>	62	Not available for jalousie doors open vertically / nicht moeglich bei den Jalousieschraenken 08J14-08J21
	60		<b>14J61</b>	65	
	80		<b>14J62</b>	67	
	100		<b>14J63</b>	71	
	120		<b>14J64</b>	76	

**DOOR STOPPER / TÜRSTOPPER**

VIEW / ANSICHT	DIMENSIONS (in cm) / ABMESSUNGEN (in cm)		CATALOGUE NUMBER / PRODUKT-SYMBOL	NET PRICE in EUR / NETTOPREIS in €		
	WIDTH / BREITE	DEPTH / TIEFE		door stopper separately / Türstopper separat bestellt	door stopper ordered with a cabinet / Türstopper bestellt mit einem Schrank	
			<b>14J65</b>	16	15	Door stopper assembled to the body of cabinet / Türstopper an der Abdeckplatte befestigt