



## Stepps Shelving Units System / Regalsystem Stepps

# STEPPS

BALMA Stepps shelving units designed by Piotr Kuchciński / Regalserie BALMA Stepps, Design: Piotr Kuchciński

Modular system of BALMA Stepps shelving units is an ideal solution for a variety of spaces like offices, public places as well as living spaces. This system allows to obtain both individual pieces of furniture and complex structures, it also shapes the architecture of the interior thanks to wall units, free-standing (double-sided) units and corner units. When using BALMA Stepps shelving units, it is possible to distinguish communication routes as well as to create work places, entertainment spots and relaxation zones. Metal ladders are connected by means of shelves or box elements, in this way ensuring a stable structure. The standard heights from 10H to 70H, 3 shelf spans, spaces with doors installed into the structure of shelving units, a wide range of additional sliding doors allowing to partly cover the inside of a shelving unit and its box elements – all those features make the system both functional and decorative. It is those elements that provide numerous possibilities for shelving units to meet functional, spacial and aesthetic needs. / Das modulare Regalsystem BALMA Stepps ist die ideale Lösung für unterschiedlichste Räume: Büros, öffentliche Räume, aber auch Wohnungen. Mit diesem System sind sowohl einzelne Möbel realisierbar als auch komplexe Lösungen für die gesamte Innenarchitektur mit Wandregalen und (beidseitig zugänglichen) freistehenden geraden Regalen und Eckregalen. Mit dem Regalsystem BALMA Stepps lassen sich Gänge schaffen aber auch Arbeitsplätze oder Bereiche zur Unterhaltung und Entspannung einrichten. Die Querelemente mit Sprossen werden mit den Regalböden oder Kistenelementen zu einem stabilen Gesamtsystem verbunden. Die Standardhöhen liegen zwischen 10H und 70H bei drei Regalbodenbreiten. Es sind in die Regalstruktur montierte Boxen mit Türen erhältlich sowie ein breites Angebot an zusätzlichen Schiebetüren, mit denen das Regal teilweise abgedeckt werden kann, darüber hinaus funktionale und dekorative Boxelemente. Dank dieser unterschiedlichen Elemente bieten sich zahllose Möglichkeiten, um das Regal an funktionale, räumliche und ästhetische Bedürfnisse anzupassen.

## COLLECTION ELEMENTS / ELEMENTE DER KOLLEKTION

SHELVING UNITS / REGALE	
LADDERS / QUERELEMENTE	Steel frame, powder-coated with cross-section of 18x18 mm. / Stahlprofil, pulverbeschichtet, 18x18 mm.
SHELVES / REGALBÖDEN	18 mm melamine chipboard, taped with 2 mm wide edge, natural veneer, 2 mm rim. Fastening to frames with the help of eccentricity connectors. Available in three widths: 34.5 cm; 70.8 cm; and 107.1 cm / Melaminbeschichtete Spanplatte 18 mm, geklebter Rand Dicke 2 mm, Naturfurnier, Unterfurnier 2 mm. Rahmenmontage mittels exzentrischer Verbindungsstücke. In 3 Breiten erhältlich 34,5; 70,8; 107,1 cm
BOTTOM PANEL / BODENPLATTE	18 mm melamine chipboard, taped with 2 mm wide edge, natural veneer - 2 mm rim. Additionally, levelling feet in the range of 5 mm. Level adjustment - with Allen key through a hole in bottom panel. / Melaminbeschichtete Spanplatte 18 mm, geklebter Rand Dicke 2 mm, Naturfurnier, Unterfurnier 2 mm. Zusätzlich: AusgleichsfüÙe im Bereich 5 mm. Regulierung über Inbusschlüssel durch Bohrung im Sockel.
PACKAGING / VERPACKUNG	Shelving units packed as flat boxes. Shipping in disassembled condition. / Die Regale sind in flache Pakete verpackt. Lieferung in nicht montiertem Zustand
OTHER INFORMATION / ZUSATZINFORMATIONEN	Within one shelving unit: shelves need to be manufactured in one technology and colour; ladders in the same colour of metal. / Für ein Regal müssen die Regalböden in derselben Technologie und Farbe hergestellt sein, die Querelemente müssen eine einheitliche Metallfarbe haben.
NOTE / ACHTUNG	While using shelves of widths of 2 and 3 S the shelves may sag because of the load. To avoid that, it is recommended to use shelf support and boxes, which will prevent shelves from sagging. / Bei der Verwendung von Regalböden der Breiten 2 und 3 S können sich diese bei Belastung durchbiegen. Um ein Durchbiegen zu verhindern, empfehlen wir die Verwendung von Regalstützen und Boxen.

CABINETS / SCHRÄNKE	
CABINETS / SCHRÄNKE	Cabinets are to be ordered separately, they require being fastened to a shelving unit. / Schränke sind getrennt zu bestellende Elemente und müssen am Regal befestigt werden.
FRONT AND BODY / FRONT UND KORPUS	18 mm melamine chipboard, taped with 2 mm wide edge / Melaminbeschichtete Spanplatte 18 mm, geklebter Rand, Dicke 2 mm natural veneer, width: 18 mm, rim 2 mm / Naturfurnier, Dicke 18 mm, Unterfurnier 2 mm
VARIANTS / VARIANTEN	cabinet with a dropped down door of height 1 OH / Schrank mit Klapptür, Höhe 1 OH cabinet with door of height 2 OH / Schrank mit Türen, Höhe 2 OH
OTHER INFORMATION / ZUSATZINFORMATIONEN	The colour of cabinet fronts and bodies may differ from the material and colour in the shelves in a shelving unit. 1 OH cabinets do not have a top panel. Cabinets are to be inserted between shelves and mounted to a shelving unit (e.g. cabinet of height of 1 OH to the shelf down, 2 OH to the ladders on sides) / Die Fronten und Korpus können in Material und Farbe von den Regalböden abweichen. Die Schränke 1 OH haben keine Deckplatte. Die Schränke werden zwischen den Regalböden montiert (Schrank der Höhe 1 OH unten an Regalböden, 2 OH an die Sprossen der Querelemente)

BOXES	
BOXES / BOXEN	Boxes do not require to be fastened to shelving elements, they are ordered separately. Except for the box mounted to 1 OH shelving unit, which can be used for sitting, needs to be screwed to the bottom panel. / Die Boxen müssen nicht an den Regalelementen montiert werden und sind separat zu bestellen. Ausnahme: Box zur Montage im Regal 1 OH, als Sitzgelegenheit nutzbar. diese muss mit der Bodenplatte verschraubt werden.
DESIGN / AUSFÜHRUNG	12 mm melamine chipboard, taped with 2 mm wide edge / Melaminbeschichtete Spanplatte 12 mm, geklebter Rand, Dicke 2 mm natural veneer width 12 mm, rim 2 mm. / Naturfurnier, Dicke 12 mm, Unterfurnier 2 mm. MDF lacquer structure width 12 mm / MDF lackiert mit Struktur, Dicke 12 mm
BOX VARIANTS / BOXVARIANTEN	open, width 1S / offen, Breite 1S with push to open doors, width 1S / mit Türen mit Push to open, Breite 1S open narrow, width 1/2 S / schmale Öffnung, Breite 1/2 S

## COLLECTION ELEMENTS / ELEMENTE DER KOLLEKTION

### SHELF SUPPORT

<b>SHELF SUPPORT / REGALSTÜTZE</b>	An element supporting shelves, prevents shelves from sagging. It can be used as a support for books/folders. / Stützelement für Regalböden, um ein Durchbiegen zu verhindern. Auch als Stütze für Bücher oder Ordner nutzbar.		
<b>DESIGN / AUSFÜHRUNG</b>	melamine chipboard 18 mm, taped with 2 mm wide edge / Melaminbeschichtete Spanplatte 18 mm, geklebter Rand, Dicke 2 mm	natural veneer width 18 mm, rim 2 mm. / Naturfurnier, Dicke 18 mm, Unterfurnier 2 mm.	MDF lacquer structure width 18 mm / MDF lackiert mit Struktur, Dicke 18 mm

### SLIDING DOOR

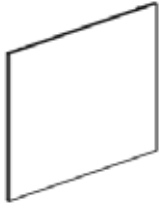
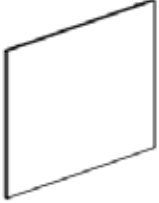
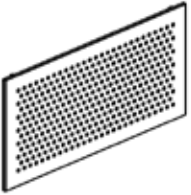
<b>SLIDING DOOR / SCHIEBETÜREN</b>	Sliding door is suspended on bottom and top glides mounted to shelves in a shelving unit. / Schiebetüren laufen in oberen und unteren, an die Regalböden montierten Schienen.		
<b>DOOR DESIGN / AUSFÜHRUNG DER TÜREN</b>	melamine chipboard 12 mm, taped with 2 mm wide edge / Melaminbeschichtete Spanplatte 12 mm, geklebter Rand, Dicke 2 mm 	natural veneer width 12 mm, rim 2 mm. / Naturfurnier, Dicke 12 mm, Unterfurnier 2 mm 	Perforated sheet / Lochblech 
<b>GLIDES / LAUFSCHIENEN</b>	Aluminium, H-shaped; door can be mounted on both sides of a glide; brakes assembled at glide ends. Optionally: 1 pc. or a set consisting of 2 pieces of glides. The set includes a sticker in the colours of: aluminium, black or white that masks screws. / Aluminium mit H-Profil; Türen beiderseits der Schienen montierbar; Bremsen am Schienenende. Optional 1 Schiene oder Satz mit 2 Schienen verfügbar. Im Satz Schraubenabdeckaufkleber in den Farben Aluminium, Schwarz oder Weiß beigefügt.		

### RULES OF CONSTRUCTING SHELVING UNITS / BEIM REGALZUSAMMENBAU BEACHTEN

<b>RULES OF CONSTRUCTING SHELVING UNITS / BEIM REGALZUSAMMENBAU BEACHTEN</b>	from 1 to 5 OH: free-standing shelving unit / 1 bis 5OH: freistehendes Regal 6 and 7 OH shelving units: fixed to the wall. The set also includes wall fixings. / 6 und 7 OH: Regal mit Wandbefestigung Winkelstücke zur Befestigung im Lieferumfang enthalten.
	Bracing module required or cabinet in the bottom part of a shelving unit - in the bottom half; examples: / Verstärkungsmodul oder Schrank im unteren Teil des Regals erforderlich - in der unteren Hälfte; Beispiele:
	a. In 6 and 7 OH shelving units, bracing module or cabinet in the first, second or third space from the bottom. / Bei den Regalen 6 und 7 OH, Verstärkungsmodul oder Schrank im ersten, zweiten oder dritten Fach von unten.
	b. 5 OH - bracing module or cabinet in the first or second space from the bottom. / 5 OH - Verstärkungsmodul oder Schrank im ersten oder zweiten Fach von unten.
	c. Exception: In 2 OH shelving unit - it can be in the first or second space. / Ausnahme: Regal 2 OH - Im ersten oder zweiten Fach einsetzbar.
	In spaces of width of 2 and 3 S (modular ones) the use of boxes and/or shelf support is recommended to stop shelves from sagging. / In Fächern der Breite 2 und 3S (modular) wird der Einsatz von Boxen oder Stützen empfohlen, um ein Durchbiegen zu verhindern.

## FINISHING / AUSFÜHRUNG

### REGAL

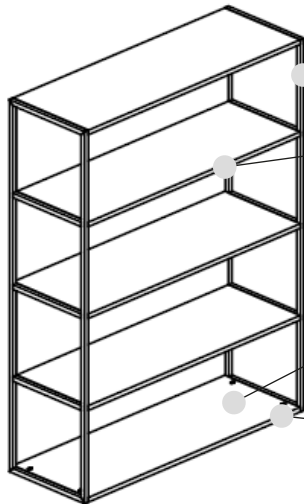

### LADDER / QUERELEMENT

- steel profile, powder painted / pulverbeschichtet

### SHELF / REGALBÖDEN

- melamine / Melaminplatte
- natural veneer / Naturfurniere

### BOTTOM PANEL / BODENPLATTE

- melamine / Melaminplatte
- natural veneer / Naturfurniere

### LEVELLING FEET / AUSGLEICHSFÜSSE

- plastic, black / schwarzer Kunststoff

### CABINETS / SCHRANKE

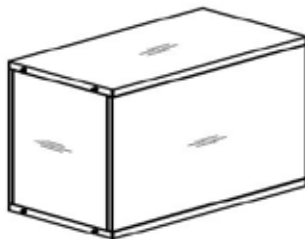

### BODY AND FRONT / KORPUS UND FRONT

- melamine / Melaminplatte
- natural veneer / Naturfurniere

### BOXES

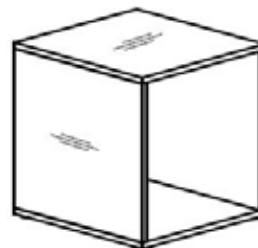

### BODY / KORPUS

- melamine / Melaminplatte
- natural veneer / Naturfurniere
- MDF mat structure varnish / Lackbeschichtung matt strukturiert

### SLIDING DOORS / SCHIEBETÜREN

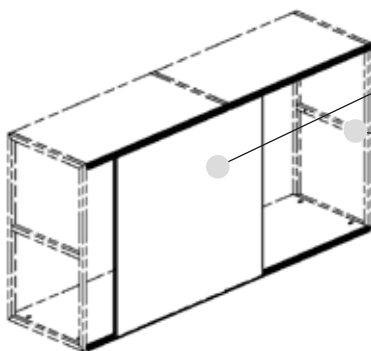

### SLIDING DOOR / SCHIEBETÜR

- melamine / Melaminplatte
- natural veneer / Naturfurniere
- perforated sheet / Lochblech

### GLIDES FOR SLIDING DOOR / SCHIEBETÜRSCHIENEN

- aluminium / Aluminium
- sticker in the colour of: / Aufkleber in der Farbe:
  - aluminium / Aluminium
  - black / Schwarz
  - white / Weiß

### SHELVING UNITS

#### LADDER / LEITER

steel, powder painted

- full colour range according to BALMA's colour chart / ganze Fabenpalette gem. BALMA-farbmuster

#### SHELF AND BOTTOM PANEL / FACHBÖDEN UND BODENPLATTE

melamine/ Melaminplatte

- full colour range according to BALMA's colour chart / ganze Fabenpalette gem. BALMA-farbmuster
- 10% additional payment / Aufpreis +10%
  - azure blue 1850 / Azurblau 1850

natural veneer / Naturfurniere

- full colour range according to BALMA's colour chart / ganze Fabenpalette gem. BALMA-farbmuster
- 10% additional payment / Aufpreis +10%
  - milk oak 4544 / Milcheiche 4544
  - cocoa oak 4545 / Kakaoeiche 4545
  - coffee oak 4546 / Kaffeeeiche 4546

### CABINETS

#### DOOR AND BODY / SCHIEBETÜR UND KORPUS

melamine/ Melaminplatte

- full colour range according to BALMA's colour chart / ganze Fabenpalette gem. BALMA-farbmuster
- 10% additional payment / Aufpreis +10%
  - azure blue 1850 / Azurblau 1850

natural veneer / Naturfurniere

- full colour range according to BALMA's colour chart / ganze Fabenpalette gem. BALMA-farbmuster
- 10% additional payment / Aufpreis +10%
  - milk oak 4544 / Milcheiche 4544
  - cocoa oak 4545 / Kakaoeiche 4545
  - coffee oak 4546 / Kaffeeeiche 4546

### BOXES

melamine/ Melaminplatte

- white / Weiss 2700
- grey / Lichtgrau 1205
- natural oak / Natureiche 0400

natural veneer / Naturfurniere

- full colour range according to BALMA's colour chart / ganze Fabenpalette gem. BALMA-farbmuster
- 10% additional payment / Aufpreis +10%
  - milk oak 4544 / Milcheiche 4544
  - cocoa oak 4545 / Kakaoeiche 4545
  - coffee oak 4546 / Kaffeeeiche 4546

MDF mat structure varnish/ Lackbeschichtung matt strukturiert

- full colour range according to BALMA's colour chart / ganze Fabenpalette gem. BALMA-farbmuster
- 10% additional payment / Aufpreis +10%
  - azure blue 1850 / Azurblau 1850

### SLIDING DOORS

melamine / Melaminplatte

- white / Weiss 2700
- grey / Lichtgrau 1205
- natural oak / Natureiche 0400

natural veneer / Naturfurniere

- full colour range according to BALMA's colour chart / ganze Fabenpalette gem. BALMA-farbmuster
- 10% additional payment / Aufpreis +10%
  - milk oak 4544 / Milcheiche 4544
  - cocoa oak 4545 / Kakaoeiche 4545
  - coffee oak 4546 / Kaffeeeiche 4546

perforated sheet

- full colour range according to BALMA's colour chart / ganze Fabenpalette gem. BALMA-farbmuster

## PRICES / PREISE

### STRAIGHT EXTERNAL LADDERS / GERADE ÄUSSERE QUERELEMENTE

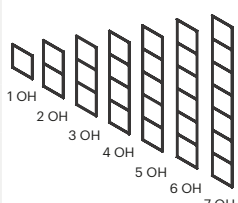
VIEW AND PROJECTION OF THE OBJECT / ANSICHT DES OBJEKTS	HEIGHT VARIANT	DIMENSIONS (in cm) / ABMESSUNGEN (in cm)			CATALOGUE NUMBER / PRODUKT SYMBOL	NET PRICE in EUR / PREIS in €	DESCRIPTION / BESCHREIBUNG
		Width / B	Depth / T	Height / H			
	1 OH	38,1	1,8	38,1	R3-101	39	Straight ladders to construct shelving units. External, with shelf holes only on one side. Ordering 1 pc. / Gerade Querelemente für Regale. Die äußeren Querelemente sind nur einseitig mit Bohrungen für Regalböden versehen. Stückweise zu bestellen.
	2 OH	38,1	1,8	74,4	R3-102	65	
	3 OH	38,1	1,8	110,7	R3-103	86	
	4 OH	38,1	1,8	147	R3-104	107	
	5 OH	38,1	1,8	183,3	R3-105	128	
	6 OH	38,1	1,8	219,6	R3-106	155	
	7 OH	38,1	1,8	255,9	R3-107	170	

### STRAIGHT MIDDLE LADDERS / GERADE QUERELEMENTE

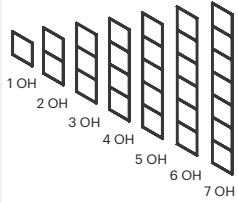
VIEW AND PROJECTION OF THE OBJECT / ANSICHT DES OBJEKTS	HEIGHT VARIANT	DIMENSIONS (in cm) / ABMESSUNGEN (in cm)			CATALOGUE NUMBER / PRODUKT SYMBOL	NET PRICE in EUR / PREIS in €	DESCRIPTION / BESCHREIBUNG
		Width / B	Depth / T	Height / H			
	1 OH	38,1	1,8	38,1	R3-121	39	Straight ladders to construct shelving units. Middle, with shelf holes on both sides. Ordering 1 pc. / Gerade Querelemente für Regale. Innere Querelemente sind beidseitig Bohrungen versehen. Stückweise zu bestellen.
	2 OH	38,1	1,8	74,4	R3-122	65	
	3 OH	38,1	1,8	110,7	R3-123	86	
	4 OH	38,1	1,8	147	R3-124	107	
	5 OH	38,1	1,8	183,3	R3-125	128	
	6 OH	38,1	1,8	219,6	R3-126	155	
	7 OH	38,1	1,8	255,9	R3-127	170	

### CORNER LADDERS / ECKQUERELEMENTE

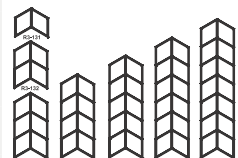
VIEW AND PROJECTION OF THE OBJECT / ANSICHT DES OBJEKTS	HEIGHT VARIANT	DIMENSIONS (in cm) / ABMESSUNGEN (in cm)			CATALOGUE NUMBER / PRODUKT SYMBOL	NET PRICE in EUR / PREIS in €	DESCRIPTION / BESCHREIBUNG
		Width / B	Depth / T	Height / H			
	1 OH	38,1	40	38,1	R3-131	63	Ladders to create 90-degree corners. Universal left/right. Ordering 1 pc. / Querelemente für rechteckige Ecken. Links/ rechts universal. Stückweise zu bestellen.
	2 OH	38,1	40	74,4	R3-132	94	
	3 OH	38,1	40	110,7	R3-133	140	
	4 OH	38,1	40	147	R3-134	165	
	5 OH	38,1	40	183,3	R3-135	196	
	6 OH	38,1	40	219,6	R3-136	226	
	7 OH	38,1	40	255,9	R3-137	250	

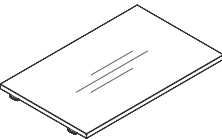
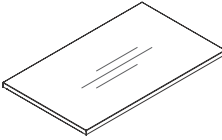
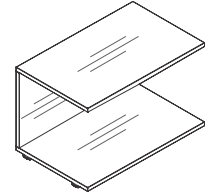
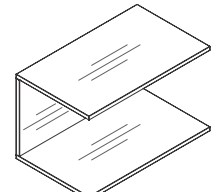

SHELVES / REGALBÖDEN								
VIEW AND PROJECTION OF THE OBJECT / ANSICHT DES OBJEKTS	WIDTH VARIANT	DIMENSIONS (in cm) / ABMESSUNGEN (in cm)			CATALOGUE NUMBER / PRODUKT SYMBOL	NET PRICE in EUR / PREIS in €		DESCRIPTION / BESCHREIBUNG
		Width / B	Depth / T	Height / H		melamine / Melaminplatte	natural veneer / Naturfurniere	
	1 S	34,5	38	1,8	R3-151	68	84	bottom panel for shelving unit, with 4 (1 S) or 6 (2 and 3 S) levelling feet / Bodenplatte für Regal mit 4 (1 S) oder 6 (2 und 3 S) Ausgleichsfüßen
	2 S	70,8	38		R3-152	79	118	
	3 S	107,1	38		R3-153	89	158	
	1 S	34,5	38	1,8	R3-154	20	51	shelf for a shelving unit / Regalboden
	2 S	70,8	38		R3-155	32	92	
	3 S	107,1	38		R3-156	44	142	
	1 S	34,5	38	38	R3-157	86	156	module bracing the structure of a shelving unit (MS), with bottom panel, dedicated to bottom space, with levelling feet, fixed to ladders / Modul zur Verstärkung der Regalkonstruktion (MS) mit Bodenplatte für das unterste Fach und Ausgleichsfüßen, zur Befestigung an den Sprossen
	2 S	70,8	38		R3-158	119	257	
	3 S	107,1	38		R3-159	147	369	
	1 S	34,5	38	38	R3-160	62	150	module bracing the structure of a shelving unit (MS), fixed to ladders / Modul zur Verstärkung der Regalkonstruktion (MS), zur Befestigung an den Sprossen
	2 S	70,8	38		R3-161	88	271	
	3 S	107,1	38		R3-162	123	411	

DEEP SHELVES / TIEFES REGALBÖDEN								
VIEW AND PROJECTION OF THE OBJECT / ANSICHT DES OBJEKTS	WIDTH VARIANT	DIMENSIONS (in cm) / ABMESSUNGEN (in cm)			CATALOGUE NUMBER / PRODUKT SYMBOL	NET PRICE in EUR / PREIS in €		DESCRIPTION / BESCHREIBUNG
		Width / B	Depth / T	Height / H		melamine / Melaminplatte	natural veneer / Naturfurniere	
	1 S	34.5	50	1.8	R3-181	24	51	deep shelf for shelving unit / tiefes Regal für Regale
	2 S	70.8	50	1.8	R3-182	36	92	
	3 S	107.1	50	1.8	R3-183	48	142	

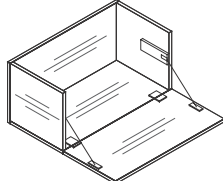
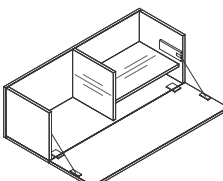
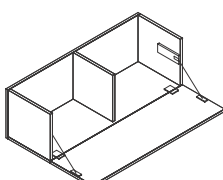

## PRICES / PREISE

CABINETS / SCHRÄNKE								
VIEW AND PROJECTION OF THE OBJECT / ANSICHT DES OBJEKTS	HEIGHT VARIANT	DIMENSIONS (in cm) / ABMESSUNGEN (in cm)			CATALOGUE NUMBER / PRODUKT SYMBOL	NET PRICE in EUR / PREIS in €		DESCRIPTION / BESCHREIBUNG
		Width / B	Depth / T	Height / H		melamine / Melaminplatte	natural veneer / Naturfurniere	
	2 S	70,8	38	34,4	R3-021	325	582	Horizontal cabinet with a drop down door. Cabinet with no top panel, to be inserted between shelves, screwed to shelves./ Schrank horizontal mit Klapptür. Schrank ohne Deckplatte zur Schraubmontage zwischen den Regalböden
	3 S	107,1	38	34,4	R3-022	377	754	Horizontal cabinet with a drop down door. Cabinet with no top panel, to be inserted between shelves, screwed to shelves. With a vertical partition and a shelf. / Schrank horizontal mit Klapptür. Schrank ohne Deckplatte zur Schraubmontage zwischen den Regalböden. Mit Vertikalfach und Regalboden.
	3 S	107,1	38	34,4	R3-023	370	696	Horizontal cabinet with a drop down door / with a vertical partition. Cabinet with no top panel, to be inserted between shelves, screwed to shelves. / Schrank horizontal mit Klapptür und Vertikalfach. Schrank ohne Deckplatte zur Schraubmontage zwischen den Regalböden. Mit Vertikalfach.

CABINETS / SCHRÄNKE								
VIEW AND PROJECTION OF THE OBJECT / ANSICHT DES OBJEKTS	HEIGHT VARIANT	DIMENSIONS (in cm) / ABMESSUNGEN (in cm)			CATALOGUE NUMBER / PRODUKT SYMBOL	NET PRICE in EUR / PREIS in €		DESCRIPTION / BESCHREIBUNG
		Width / B	Depth / T	Height / H		melamine / Melaminplatte	natural veneer / Naturfurniere	
	2 S	70,8	38	34,4	R3-021	325	582	2 S wide cabinet with 2 drawers. To be inserted between shelves./ 2 S breiter Schrank mit 2 Schubladen. Zwischen den Regalen einzufügen.
	3 S	107,1	38	34,4	R3-022	377	754	3 S wide cabinet with 2 drawers. To be inserted between shelves./ 3 S breiter Schrank mit 2 Schubladen. Zwischen den Regalen einzufügen.



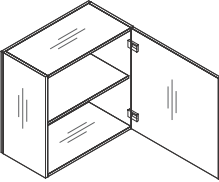
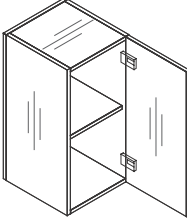

VERTICAL CABINET WITH DOOR/1-SHELF / SCHRANK VERTIKAL MIT TÜREN / 1 REGALBODEN

VIEW AND PROJECTION OF THE OBJECT / ANSICHT DES OBJEKTS	HEIGHT VARIANT	DIMENSIONS (in cm) / ABMESSUNGEN (in cm)			CATALOGUE NUMBER / PRODUKT SYMBOL	NET PRICE in EUR / PREIS in €		DESCRIPTION / BESCHREIBUNG
		Width / B	Depth / T	Height / H		melamine / Melaminplatte	natural veneer / Naturfurniere	
	2 S	70,8	38	70,7	R3-031	168	522	Vertical cabinet with a door and 1 shelf. Cabinet of height of 2 OH, 2 modules (2S) wide, to be inserted between shelves, fastened to ladders. Right or left door - optional. / Schrank vertikal mit Türen / 1 Regalboden. Schrank in der Höhe 2 OH, Breite 2 Module (2S), zur Montage zwischen den Regalböden an die Querelemente. Tür rechts oder links optional.
	1 S	34,5	38	70,7	R3-032	137	495	Vertical cabinet with a door and 1 shelf. Cabinet of height of 2 OH, 1 module (1S) wide, to be inserted between shelves, fastened to the ladders. Door right or left - optional. / Schrank vertikal mit Türen / 1 Regalboden Schrank in der Höhe 2 OH, Breite 1 Modul (1S), zur Montage zwischen den Regalböden an die Querelemente. Tür rechts oder links optional.

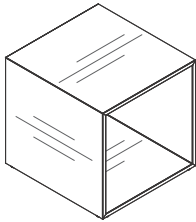
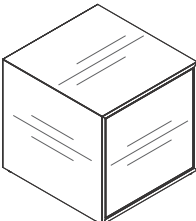
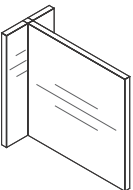
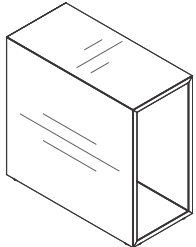
## PRICES / PREISE

BOXES / BOXEN								
VIEW AND PROJECTION OF THE OBJECT / ANSICHT DES OBJEKTS	DIMENSIONS (in cm) / ABMESSUNGEN (in cm)			CATALOGUE NUMBER / PRODUKT SYMBOL	NET PRICE in EUR / PREIS in €			DESCRIPTION / BESCHREIBUNG
	Width / B	Depth / T	Height / H		melamine / Melaminplatte	natural veneer / Naturfurniere	MDF mat structure varnish / MDF Lackbeschichtung matt strukturiert	
	34,4	36,1	34,3	R3-011	105	315	181	open box inserted between shelves, does not require fixing. / offene Box zwischen den Regalböden einsetzbar, keine Befestigung nötig
	34,4	36,1	34,3	R3-012	123	384	222	box with a door, with push-to-open hinges, inserted between shelves, does not require fixing. / Box mit Türen, Scharniere Push to open, zwischen den Regalböden einsetzbar, keine Befestigung nötig
	17	36,3	34,5	R3-014	37	125	82	shelf support to be inserted between shelves, to support the shelf / Regalstütze zum Einsetzen zwischen den Regalböden
	17	36,1	34,3	R3-015	74	286	168	box of width of half space (1/2 S), inserted between shelves, does not require fixing / Box mit halber Fachbreite (1/2 S), zum Einsetzen zwischen den Regalböden, keine Befestigung nötig

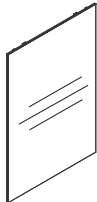
SLIDING DOORS OF WIDTH OF 2 S / SCHIEBETÜR DER BREITE 2 S



VIEW AND PROJECTION OF THE OBJECT / ANSICHT DES OBJEKTS	HEIGHT VARIANT	DIMENSIONS (in cm) / ABMESSUNGEN (in cm)			CATALOGUE NUMBER / PRODUKT SYMBOL	NET PRICE in EUR / PREIS in €			DESCRIPTION / BESCHREIBUNG	REMARKS / DETAILS
		Width / B	Depth / T	Height / H		melamine / Melaminplatte	natural veneer / Naturfurniere	perforated sheet / Lochblech		
	1 OH	74,4	1,2	36	R3-041	272	335	429	sliding doors suspended on glides screwed to the shelves. Width of 2 spaces (S). When ordering please indicate which glide will be needed for the set./ Schiebetür auf mit den Regalböden verschraubten Schienen befestigt. Breite 2 Fächer (S). Bei der Bestellung ist die gewünschte Schiene anzugeben.	1 glide included / 1 Schiene im Satz
						377	440	534		2 glides included / 2 Schienen im Satz
	2 OH	74,4	1,2	72,3	R3-042	280	360	470		1 glide included / 1 Schiene im Satz
						385	465	575		2 glides included / 2 Schienen im Satz
	3 OH	74,4	1,2	108,6	R3-043	285	382	510	1 glide included / 1 Schiene im Satz	
						390	487	615	2 glides included / 2 Schienen im Satz	
	4 OH	74,4	1,2	144,9	R3-044	296	412	555	1 glide included / 1 Schiene im Satz	
						401	517	660	2 glides included / 2 Schienen im Satz	

## PRICES / PREISE

SLIDING DOORS OF WIDTH OF 3 S / SCHIEBETÜR DER BREITE 3 S										
VIEW AND PROJECTION OF THE OBJECT / ANSICHT DES OBJEKTS	HEIGHT VARIANT	DIMENSIONS (in cm) / ABMESSUNGEN (in cm)			CATA-LOGUE NUMBER / PRODUKT SYMBOL	NET PRICE in EUR / PREIS in €			DESCRIPTION / BESCHREIBUNG	REMARKS / DETAILS
		Width / B	Depth / T	Height / H		melamine / Melaminplatte	natural veneer / Naturfurniere	perforated sheet / Lochblech		
	1 OH	110,7	1,2	36	R3-045	277	349	452	sliding doors fixed on glides screwed to shelves. Width of 3 spaces (S). When ordering please indicate which glide will be needed for the set. / Schiebetür auf mit den Regalböden verschraubten Schienen befestigt. Breite 3 Fächer (S). Bei der Bestellung ist die gewünschte Schiene anzugeben.	1 glide included / 1 Schiene im Satz
						382	454	557		2 glides included / 2 Schienen im Satz
	2 OH	110,7	1,2	72,3	R3-046	288	385	515		1 glide included / 1 Schiene im Satz
						393	490	620		2 glides included / 2 Schienen im Satz
	3 OH	110,7	1,2	108,6	R3-047	299	436	575		1 glide included / 1 Schiene im Satz
						404	541	680		2 glides included / 2 Schienen im Satz
	4 OH	110,7	1,2	144,9	R3-048	310	472	564		1 glide included / 1 Schiene im Satz
						415	577	669		2 glides included / 2 Schienen im Satz

RUNNING GLIDES FOR SLIDING DOORS / SCHIENEN FÜR SCHIEBETÜREN				
VIEW AND PROJECTION OF THE OBJECT / ANSICHT DES OBJEKTS	DIMENSIONS (in cm) / ABMESSUNGEN (in cm)	glide for width of modules	DESCRIPTION / BESCHREIBUNG	
			Width	
	143,4	4 S	Glides for sliding doors, bottom glide and top glide included, ordered as a set together with a sliding door. Fixed on shelves. / Schiebetürschienensatz oben und unten, im Paket mit Schiebetüren zu bestellen. An den Regalböden zu montieren.	
	179,7	5 S		
	216	6 S		
	252,3	7 S		
	288,6	8 S		
	324,9	9 S		
	361,2	10 S		
	397,5	11 S		

FASTENING OF RACKS TO THE WALL AND CEILING /  
BEFESTIGUNG VON RACKS AN DER WAND UND DECKE

VIEW AND PROJECTION OF THE OBJECT / ANSICHT DES OBJEKTS	DIMENSIONS (in cm) / ABMESSUNGEN (in cm)			CATALOGUE NUMBER / PRODUKT SYMBOL	NET PRICE in EUR / PREIS in €	DESCRIPTION / BESCHREIBUNG
	Width / B	Depth / T	Height / H			
				<b>R3-171</b>	4	wall mounting bracket, 1 piece. Powder coated metal. / Wandhalterung, 1 Stück. Pulverbeschichtetes Metall.
	38.1	1.8	50-80	<b>R3-172</b>	64	fixing the unit to the ceiling. Adjustment range 50-80 cm. Powder coated metal. / Befestigung der Leiter an der Decke. Einstellbereich 50-80 cm. Pulverbeschichtetes Metall.
	38.1	1.8	35-50	<b>R3-173</b>	55	fixing the unit to the ceiling. Adjustment range 35-50 cm. Powder coated metal. / Befestigung der Leiter an der Decke. Einstellbereich 35-50 cm. Pulverbeschichtetes Metall.