

Contents

	page
Schränke "ECONOMIC" Rückwand 3mm	2
Schränke "STANDARD" Rückwand 8mm	18
Einbaurahmen für Hängeregister	59
Rollcontainer "ECONOMIC"	61
Rollcontainer "STANDARD"	63
Rollcontainer "ECONOMIC" and "STANDARD" - accessories	67
Metall Rollcontainer	68
Metall Rollcontainer - accessories	74

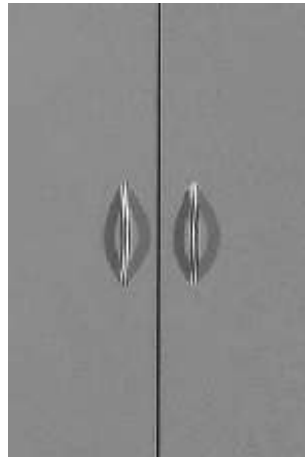

OFFICE FURNITURE CABINETS

CABINETS

MELAMINE FURNITURE COLOUR FINISHINGS

DESK THICKNESS 18 mm

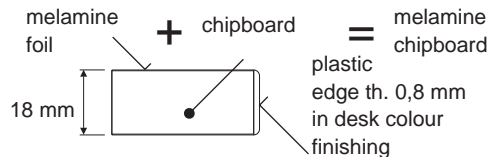

CARCASS COLOUR FINISHINGS

STANDARD COLOUR FINISHINGS

Delivery term of furniture in standard colour finishings is four weeks.

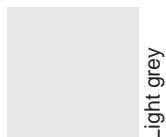

ADDITIONAL COLOUR FINISHINGS

Delivery term of furniture in additional colour finishings is six weeks or by agreement with the seller.



DOOR COLOUR FINISHINGS



ADDITIONAL COLOUR FINISHINGS

Delivery term of furniture in additional colour finishings is six weeks or by agreement with the seller.

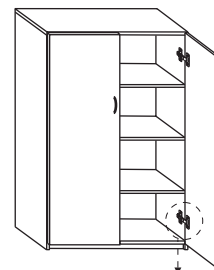
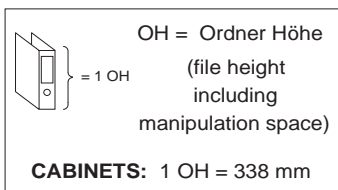
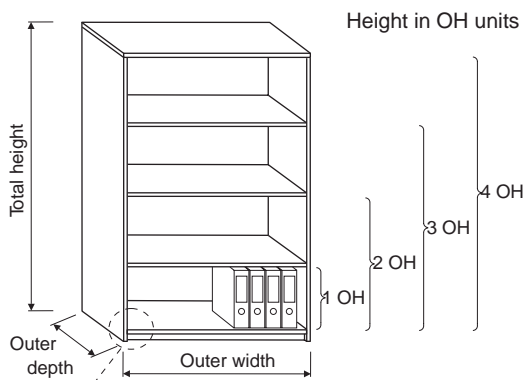
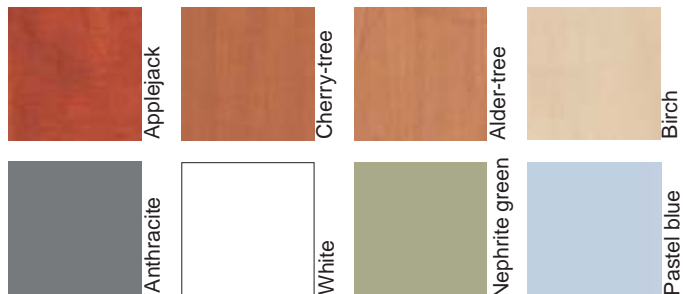

Cabinets carcass: agglutinated with pins



Door hinges Hettich



METAL ROUNDED HANDLES
 colour finishing black or silver





CABINETS "ECONOMIC"

- cabinets with socle
- carcass in UNI finishing
- door in UNI or wooden finishings
- the cabinets are not suitable to be placed in an open space as they don't have a visual back
- glass door: clear glass

Fixed shelf

- fixed into the carcass
- it is not possible to remove the shelf additionally



Door covering the carcass



Shelf stabilizers

metal rollers 5/5 mm



Locking with the help of one-way lock



LOCKING SYSTEMS "HÄFELE"

- one-way locks
- two-way locks
- general key available

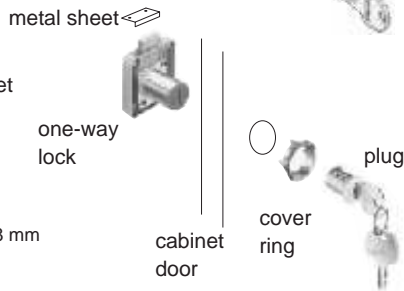

Back fastened to carcass rabbet

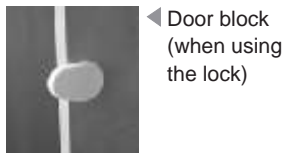
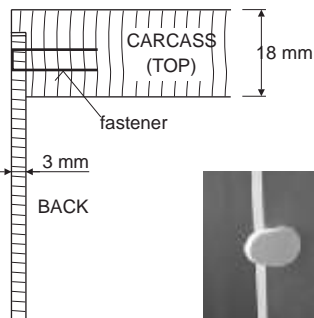

Door block (when using the lock)



▲ Lock metal sheet

Metal rounded handles in colour finishing black or silver



The handles bolt distance is 96 mm.

Cabinet socle

Socle on plastic gliders equipped with adjusting elements for floor leveling

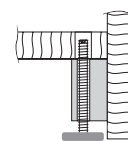

Dimensions are stated in millimetres. The products weight allowance is ± 5%.

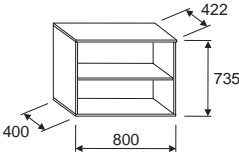
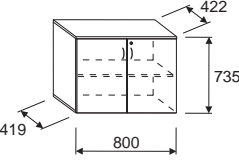
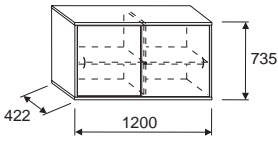
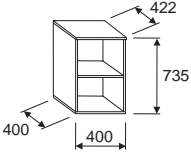
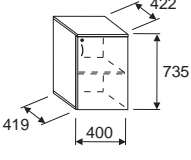
Schema	Description	Weight	Product variant	Art. No.	Price
EXTENSION CABINETS width 800 mm					
	Cabinet open, can be placed next to the desk, cabinet top finishing corresponding to the top of the desk	22,8		SCEO28	88,00
	Cabinet with door, can be placed next to the desk one-way lock available cabinet top finishing corresponding to the top of the desk	32,7	without lock	SCED28	145,00
		32,8	with lock	SCED28L	159,00
width 1200 mm					
	Cabinet with sliding door, can be placed next to the desk, cabinet top finishing corresponding to the top of the desk	48,0	without lock	SCEM22	204,00
		48,1	with lock	SCEM22L	219,00
width 400 mm					
	Cabinet open, can be placed next to the desk, cabinet top finishing corresponding to the top of the desk	15,0		SCEO24	57,00
	Cabinet with door, can be placed next to the desk one-way lock available cabinet top finishing corresponding to the top of the desk	19,5	without lock	SCED24	85,00
		19,6	with lock	SCED24L	99,00

Dimensions are stated in millimetres. The products weight allowance is 5%.

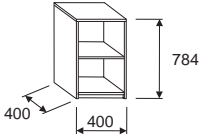
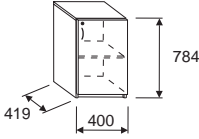
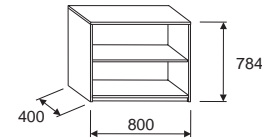
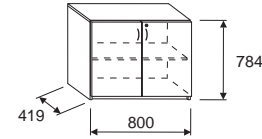
Schema	Description	Weight	Product variant	Art. No.	Price
CABINET OPEN width 400 mm		Kg			EUR
	Cabinet open,				
	- stand-alone, non-extending the working desk	15,5		SCO24	63,00
CABINET WITH DOOR					
	Cabinet with door				
	- one-way lock available	20,5	without lock	SCD24	89,00
	- stand-alone, non-extending the working desk	20,6	with lock	SCD24L	107,00
CABINET OPEN width 800 mm					
	Cabinet open,				
	- stand-alone, non-extending the working desk	23,5		SCO28	89,00
CABINET WITH DOOR					
	Cabinet with door				
	- one-way lock available	33,4	without lock	SCD28	149,00
	- stand-alone, non-extending the working desk	33,5	with lock	SCD28L	165,00

Dimensions are stated in millimetres. The products weight allowance is 5%.

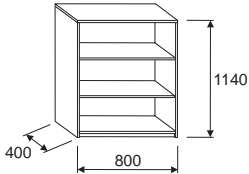
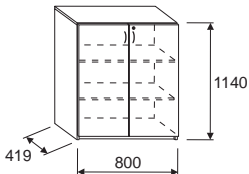
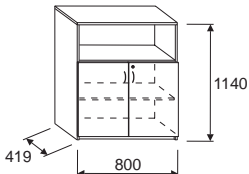
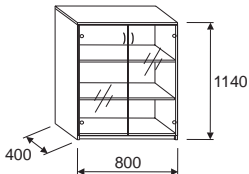
Schema	Description	Weight	Product variant	Art. No.	Price
CABINET OPEN width 800 mm		Kg			EUR
	Cabinet open with shelves	25,0		SCO38	106,00
	CABINET WITH DOOR				
	Cabinet with door	37,2	without lock	SCD38	177,00
	- one-way lock available	37,3	with lock	SCD38L	193,00
CABINET COMBINED					
	Cabinet combined, shelves				
	door/open element	33,2	without lock	SCDO3821	164,00
	- one-way lock available	33,3	with lock	SCDO3821L	179,00
CABINET WITH FULL GLASS DOOR					
	Cabinet with glass door, shelves	37,2	without lock	SCG38	192,00

Dimensions are stated in millimetres. The products weight allowance is 5%.

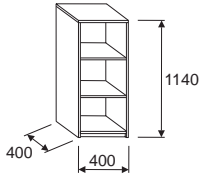
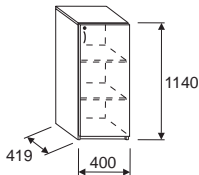
Schema	Description	Weight	Product variant	Art. No.	Price
CABINET OPEN width 400 mm		Kg			EUR
	Cabinet open with shelves	22,4		SCO34	84,00
	CABINET WITH DOOR				
	Cabinet with door, shelves	28,6	without lock	SCD34	119,00
	- one-way lock available	28,7	with lock	SCD34L	135,00

Dimensions are stated in millimetres. The products weight allowance is 5%.

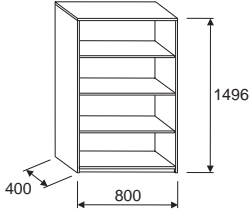
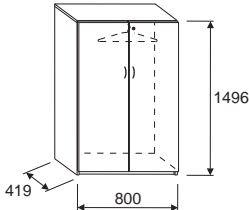
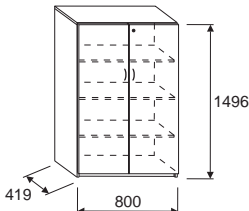
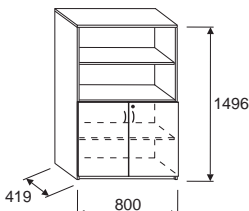
Schema	Description	Weight	Product variant	Art. No.	Price
CABINET OPEN width 800 mm		Kg			EUR
	Cabinet open with shelves	42,4		SCO48	125,00
WARDROBE					
	Wardrobe with door	46,2	without lock	SCW48	189,00
	- equipped with an extractable bar for coat hangers - one-way lock available	46,3	with lock	SCW48L	206,00
CABINET WITH DOOR					
	Cabinet with door	57,8	without lock	SCD48	205,00
	- one-way lock available	57,9	with lock	SCD48L	219,00
CABINET COMBINED					
	Cabinet combined, shelves	50,6	without lock	SCDO4822	179,00
	door/open element - one-way lock available	50,7	with lock	SCDO4822L	199,00

Dimensions are stated in millimetres. The products weight allowance is 5%.

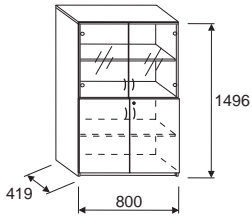
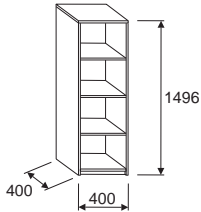
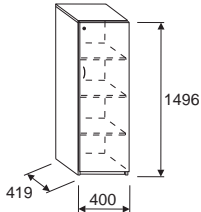
Schema	Description	Weight	Product variant	Art. No.	Price
CABINET COMBINED width 800 mm		Kg			EUR
	Cabinet combined, shelves				
	full door/glass door	58,1	without lock	SCDG4822	268,00
	- one-way lock available only for full door	58,2	with lock	SCDG4822L	284,00
CABINET OPEN width 400 mm					
	Cabinet open with shelves				
		29,0		SCO44	99,00
CABINET WITH DOOR					
	Cabinet with door				
	- one-way lock available	37,1	without lock	SCD44	139,00
		37,2	with lock	SCD44L	156,00

Dimensions are stated in millimetres. The products weight allowance is 5%.

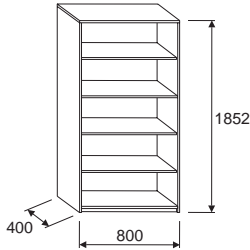
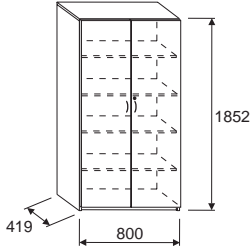
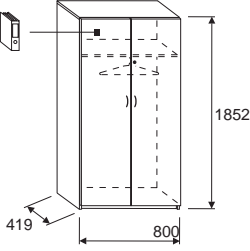
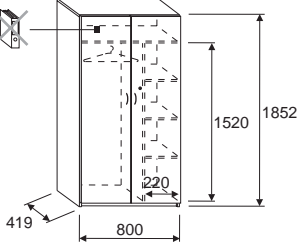
Schema	Description	Weight	Product variant	Art. No.	Price
CABINET OPEN width 800 mm		Kg			EUR
	Cabinet open with shelves	51,5		SCO58	149,00
CABINET WITH DOOR					
	Cabinet with door				
	- one-way lock available	71,0	without lock	SCD58	244,00
		71,1	with lock	SCD58L	259,00
WARDROBE WITH DOOR					
	Wardrobe with door				
	- equipped with an extractable bar for coat hangers	55,6	without lock	SCW58	219,00
		55,7	with lock	SCW58L	238,00
	- one-way lock available				
	Wardrobe with door partition, shelves				
	- equipped with an extractable bar for coat hangers	67,3	without lock	SCWS58	259,00
		67,4	with lock	SCWS58L	279,00
	- one-way lock available				

Dimensions are stated in millimetres. The products weight allowance is 5%.

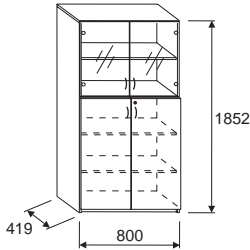
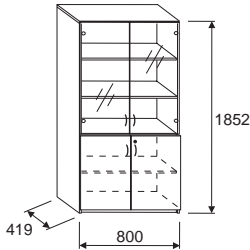
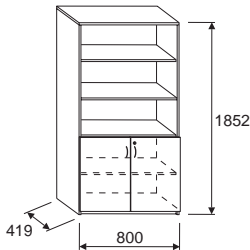
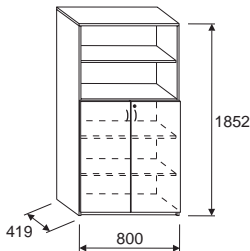
Schema	Description	Weight	Product variant	Art. No.	Price
	Cabinet combined, shelves				
	full door/glass door	71,0	without lock	SCDG5832	294,00
	- one-way lock available only for full door	71,1	with lock	SCDG5832L	309,00
	Cabinet combined, shelves				
	full door/glass door	71,0	without lock	SCDG5823	306,00
	- one-way lock available only for full door	71,1	with lock	SCDG5823L	319,00
	Cabinet combined, shelves				
	door/open element	59,7	Without lock	SCDO5823	207,00
	- one-way lock available	59,8	with lock	SCDO5823L	219,00
	Cabinet combined, shelves				
	door/open element	63,5	without lock	SCDO5832	219,00
	- one-way lock available	63,6	with lock	SCDO5832L	236,00

Dimensions are stated in millimetres. The products weight allowance is 5%.

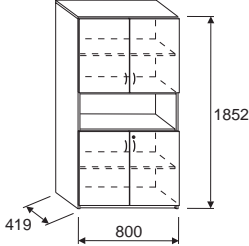
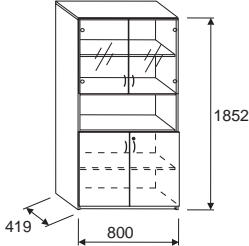
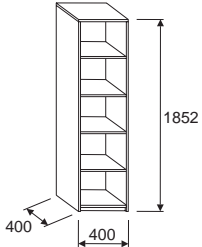
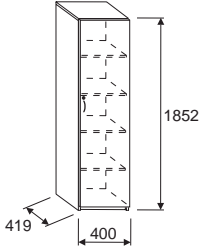
Schema	Description	Weight	Product variant	Art. No.	Price
CABINET COMBINED width 800 mm		Kg			EUR
	Cabinet combined, shelves				
	door/open element/ door	67,9	without lock	SCDOD58212	264,00
	- one-way lock available only for full door	68,0	with lock	SCDOD58212L	279,00
	Cabinet combined, shelves				
	glass door/ open element/ full door	67,9	without lock	SCDOG58212	289,00
	- one-way lock available only for full door	68,0	with lock	SCDOG58212L	308,00
CABINET OPEN width 400 mm					
	Cabinet open with shelves				
		35,5		SCO54	126,00
CABINET WITH DOOR					
	Cabinet with door				
	- one-way lock available	45,5	without lock	SCD54	173,00
		45,6	with lock	SCD54L	189,00

Dimensions are stated in millimetres. The products weight allowance is 5%.

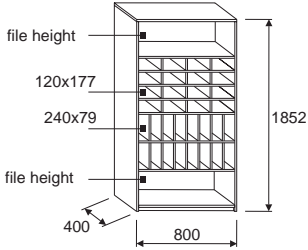
Schema	Description	Weight		Art. No.	Price
CABINET FOR LETTERS AND OTHER CORRESPONDENCE					
	<p>Cabinet for arrival letters and other correspondence</p> <p>- pigeon-holes for different sizes of consignments</p> <p>- file shelves</p>	<p>Kg</p> <p>93,8</p>		<p>SCO58T</p>	<p>EUR</p> <p>349,00</p>
Empty row for additional items					

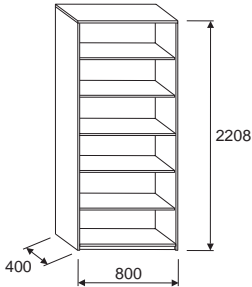
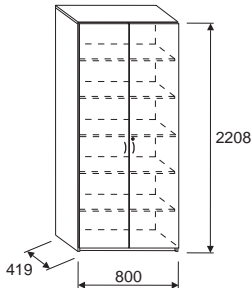
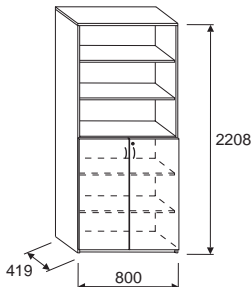

Dimensions are stated in millimetres. The products weight allowance is 5%.

Schema	Description	Weight	Product variant	Art. No.	Price
CABINET OPEN width 800 mm		Kg			EUR
	Cabinet open with shelves	60,6		SCO68	184,00
	CABINET WITH DOOR				
	Cabinet with door				
	- one-way lock available	84,8	without lock	SCD68	287,00
		84,9	with lock	SCD68L	299,00
CABINET COMBINED					
	Cabinet combined, shelves				
	door/open element	72,6	without lock	SCDO6833	255,00
	- one-way lock available	72,7	with lock	SCDO6833L	269,00

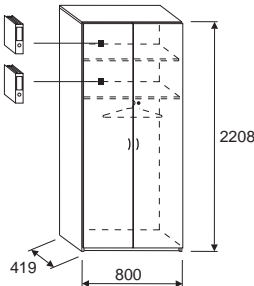
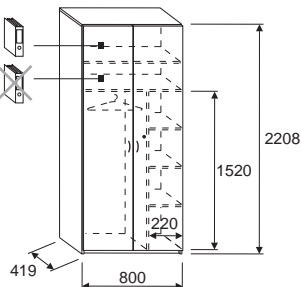
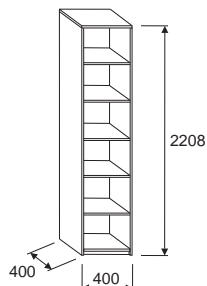
Dimensions are stated in millimetres. The products weight allowance is 5%.

Schema	Description	Weight	Product variant	Art. No.	Price
WARDROBE width 800 mm		Kg			EUR
	Wardrobe with door				
	- equipped with 2 shelves and 1 extractable bar for coat hangers	69,2	without lock	SCW68	259,00
	- one-way lock available	69,3	with lock	SCW68L	279,00
	Wardrobe with partition, door				
	- equipped with 2 shelves and 1 extractable bar for coat hangers	80,9	without lock	SCWS68	306,00
	- one-way lock available	81,0	with lock	SCWS68L	319,00
CABINET OPEN width 400 mm					
	Cabinet open with shelves				
		42,1		SCO64	149,00

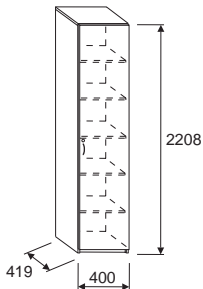
Dimensions are stated in millimetres. The products weight allowance is 5%.

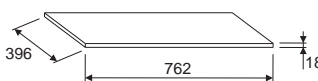
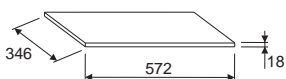
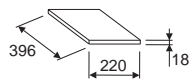
Schema	Description	Weight	Product variant	Art. No.	Price
CABINET WITH DOOR width 400 mm		Kg			EUR
	Cabinet with door				
	- one-way lock available	54,1	without lock	SCD64	199,00
		54,2	with lock	SCD64L	217,00
for cabinets type "SCO", "SCD"					
	width 400 mm				
	additional shelf for width 400 mm	2,2	additional shelf	SSW04F4	7,00
	- including stabilizers				
for type "SCO", "SCD" and combined cabinets					
	width 800 mm				
	additional shelf for width 800 mm	3,9	additional shelf	SSW08F4	11,00
	- including stabilizers				
for cabinets type "SCM"					
	width 1200 mm				
	additional shelf for cabinet with sliding door 1200 mm	2,8	additional shelf	SSWM12F4	9,00
	- including stabilizers				
for cabinets type "SCWS"					
	width 220 mm				
	additional shelf for wardrobe with partition	1,2	additional Shelf	SSWS02F4	7,00
	- including stabilizers				

**MELAMINE FURNITURE
COLOUR FINISHINGS
FOR THICKNESS**

- 18 mm
- 25 mm

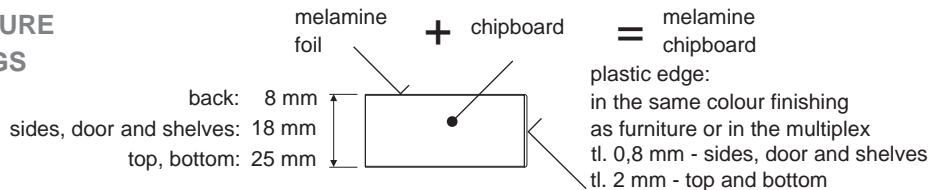

STANDARD COLOUR FINISHINGS

Delivery term of furniture in standard colour finishings is four weeks.



ADDITIONAL COLOUR FINISHINGS

Delivery term of furniture in additional colour finishings is six weeks or by agreement with the seller.



DOOR COLOUR FINISHINGS

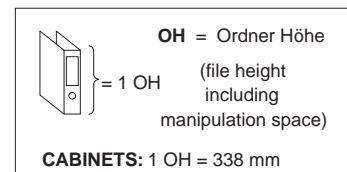
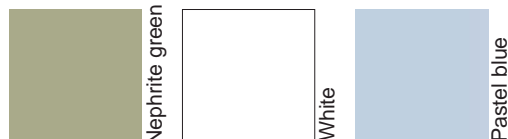

SHUTTER DOOR FINISHINGS

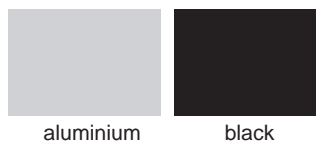

Cabinet with shutter door

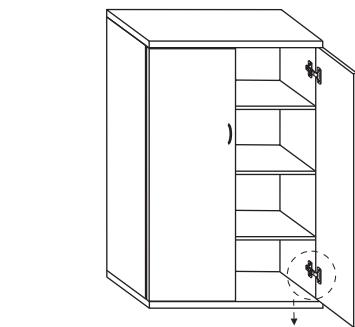

Häfele locks



Metal rounded handles in colour finishings silver or black

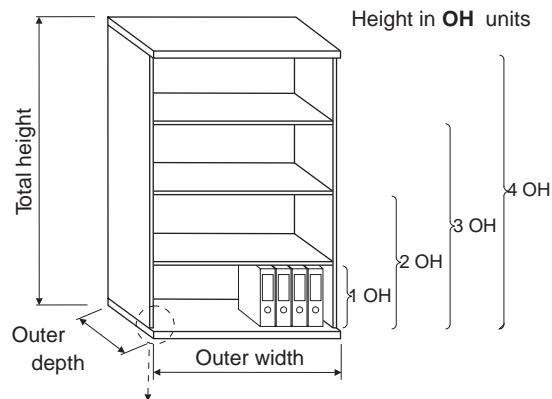

Cabinets carcass: dismantlable metal connectors



Door hinges Hettich



CABINETS "STANDARD"

- carcass in UNI or wooden colour finishings
- door in UNI or wooden colour finishings
- the cabinets are suitable to be placed in an open space as they have a visual back
- glass door: clear glass

Fixed shelf

- attached in the carcass with the help of metal fittings
- if necessary it is possible to take the shelf out



Door is placed between top and bottom
The top can be equipped with the multiplex edge



Safety shelves stabilizers

- preventing the fall out of the shelves
- additional shelves have holes for the safety shelves stabilizers



Locking with the help of one-way lock



LOCKING SYSTEMS "HÄFELE"

- one-way locks
- two-way locks
- general key available



Melamine back fixed to the rabbet on the carcass

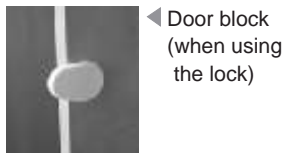
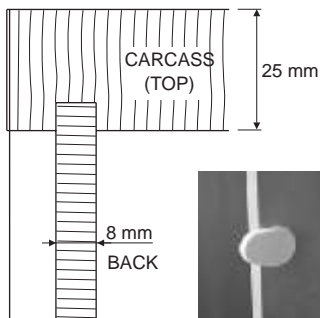
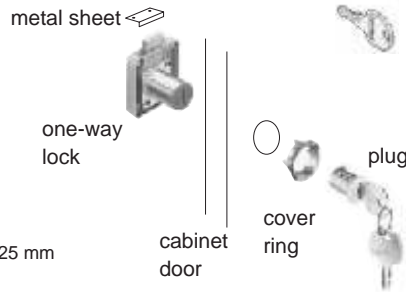

Door block (when using the lock)



▲ Lock metal sheet

Metal rounded handles in colour finishings silver or black

The handles bolt distance is 96 mm.



Cabinets bottom with adjusting elements for floor levelling

- the rectification is regulated by the allen head screw
- the vent for the rectification is covered by a plastic plug.

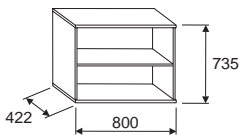
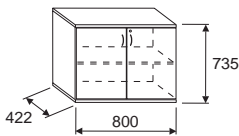
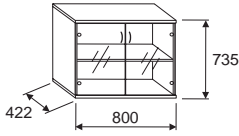
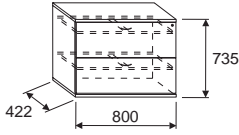
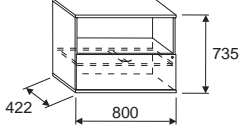

Dimensions are stated in millimetres. The products weight allowance is 5%.

Schema	Description	Weight	Product variant	Art. No.	Price
CABINET OPEN width 800 mm		Kg			EUR
	Cabinet open with shelves	27,0		ECO0748	119,00
CABINET WITH DOOR					
	Cabinet with door				
	- one-way lock available	34,4	without lock	ECD0748	176,00
		34,5	With lock	ECD0748L	189,00
CABINET WITH GLASS DOOR					
	Cabinet with glass door				
		33,3		ECG0748	204,00
CABINET WITH HANGING FILE FRAMES					
HANGING FILE FRAMES WITH THE FRONT PANELS	Cabinet with hanging file frames				
		41,5	without lock	ECR0748	424,00
	- 2 hanging file frames	41,7	with lock	ECR0748L	479,00
	- central locking available				
CABINET WITH HANGING FILE FRAME - COMBINED					
HANGING FILE FRAMES WITH THE FRONT PANELS	Cabinet with hanging file frame - combined				
		36,3	without lock	ECRO0748	255,00
	- 1 hanging file frame	36,4	with lock	ECRO0748L	269,00
	- open element				
	- central locking available				

Dimensions are stated in millimetres. The products weight allowance is 5%.

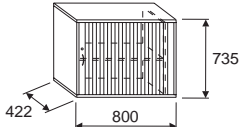
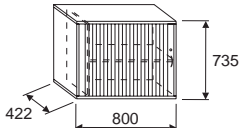
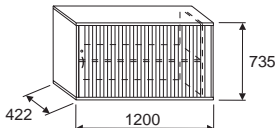
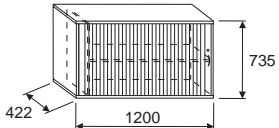
Schema	Description	Weight	Product variant	Art. No.	Price	
CABINETS WITH SHUTTER DOOR width 800 mm						
	Cabinet with shutter door, right-handed shutter colour finishings: - black - aluminium	35,9	black	Without lock	ECS07485	216,00
		36,0		with lock	ECS07485L	245,00
	- one-way lock available	35,9	aluminium	Without lock	ECS07486	229,00
		36,0		with lock	ECS07486L	259,00
width 1200 mm						
	Cabinet with shutter door, left-handed shutter colour finishings: - black - aluminium	35,9	black	Without lock	ECSL7485	216,00
		36,0		with lock	ECSL7485L	245,00
	- one-way lock available	35,9	aluminium	Without lock	ECSL7486	229,00
		36,0		with lock	ECSL7486L	259,00
	Cabinet with shutter door, right-handed shutter colour finishings: - black - aluminium	48,4	black	Without lock	ECS07425	304,00
		48,5		with lock	ECS07425L	334,00
	- one-way lock available	48,4	aluminium	Without lock	ECS07426	329,00
		48,5		with lock	ECS07426L	359,00
	Cabinet with shutter door, left-handed shutter colour finishings: - black - aluminium	48,4	black	without lock	ECSL7425	304,00
		48,5		with lock	ECSL7425L	334,00
	- one-way lock available	48,4	aluminium	Without lock	ECSL7426	329,00
		48,5		with lock	ECSL7426L	359,00

Dimensions are stated in millimetres. The products weight allowance is 5%.

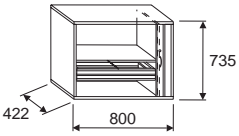
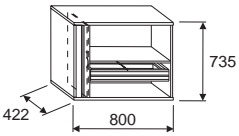
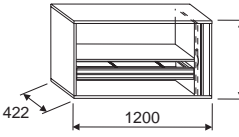
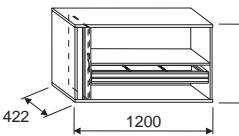
Schema	Description	Weight	Product variant	Art. No.	Price	
		Kg	Shutter door colour		EUR	
<p>CABINETS WITH HANGING FILE FRAMES AND SHUTTER DOOR</p> <p>width 800 mm</p>  <p>Hanging file frame for 1 row of files</p> <p>one-way lock available</p>	<p>Cabinets with shutter door right-handed</p> <p>- 1x shelf</p> <p>- 1x hanging file frame</p> <p>- 1x crossbar in colour: black</p>	41,9	black	Without lock	ECST07485	455,00
		42,0		with lock	ECST07485L	485,00
		41,9	aluminium	Without lock	ECST07486	469,00
		42,0		with lock	ECST07486L	499,00
	<p>Hanging file frame for 1 row of files</p> <p>one-way lock available</p>	<p>shutter colour finishings</p> <p>- black</p> <p>- aluminium</p>				
 <p>Hanging file frame for 1 row of files</p> <p>one-way lock available</p>	<p>Cabinets with shutter door left-handed</p> <p>- 1x shelf</p> <p>- 1x hanging file frame</p> <p>- 1x crossbar in colour: black</p>	41,9	black	Without lock	ECSTL7485	455,00
		42,0		with lock	ECSTL7485L	485,00
		41,9	aluminium	Without lock	ECSTL7486	469,00
		42,0		with lock	ECSTL7486L	499,00
<p>width 1200 mm</p>  <p>Hanging file frame for 2 rows of files</p> <p>one-way lock available</p>	<p>Cabinets with shutter door right-handed</p> <p>- 1x shelf</p> <p>- 1x hanging file frame</p> <p>- 2x crossbars in colour: black</p>	57,4	black	Without lock	ECST07425	559,00
		57,5		with lock	ECST07425L	589,00
		57,4	aluminium	Without lock	ECST07426	587,00
		57,5		with lock	ECST07426L	617,00
 <p>Hanging file frame for 2 rows of files</p> <p>one-way lock available</p>	<p>Cabinets with shutter door left-handed</p> <p>- 1x shelf</p> <p>- 1x hanging file frame</p> <p>- 2x crossbars in colour: black</p>	57,4	black	Without lock	ECSTL7425	559,00
		57,5		with lock	ECSTL7425L	589,00
		57,4	aluminium	Without lock	ECSTL7426	587,00
		57,5		with lock	ECSTL7426L	617,00

Dimension are stated in millimetres. The products weight allowance is 5%.

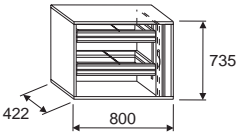
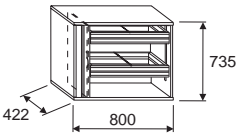
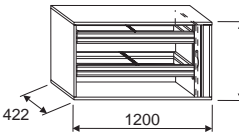
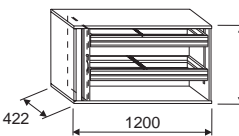
Schema	Description	Weight	Product variant	Art. No.	Price	
		Kg	Shutter door colour		EUR	
 <p>width 800 mm</p> <p>Hanging file frame for 1 row of files</p> <p>one-way lock available</p>	<p>Cabinet with shutter door right-handed</p> <p>- 2x hanging file frames</p> <p>- 2x crossbars</p> <p>in colour: black</p> <p>shutter colour finishings</p> <p>- black</p> <p>- aluminium</p>	47,9	black	without lock	ECST207485	708,00
		48,0		with lock	ECST207485L	738,00
		47,9	aluminium	Without lock	ECST207486	725,00
		48,0		with lock	ECST207486L	754,00
 <p>width 800 mm</p> <p>Hanging file frame for 1 row of files</p> <p>one-way lock available</p>	<p>Cabinet with shutter door left-handed</p> <p>- 2x hanging file frames</p> <p>- 2x crossbars</p> <p>in colour: black</p> <p>shutter colour finishings:</p> <p>- black</p> <p>- aluminium</p>	47,9	black	Without lock	ECST2L7485	708,00
		48,0		with lock	ECST2L7485L	738,00
		47,9	aluminium	Without lock	ECST2L7486	725,00
		48,0		with lock	ECST2L7486L	754,00
 <p>width 1200 mm</p> <p>Hanging file frame for 2 rows of files</p> <p>one-way lock available</p>	<p>Cabinet with shutter door right-handed</p> <p>- 2x hanging file frames</p> <p>- 4x crossbars</p> <p>in colour: black</p> <p>shutter colour finishings:</p> <p>- black</p> <p>- aluminium</p>	66,4	black	Without lock	ECST207425	829,00
		66,5		with lock	ECST207425L	859,00
		66,4	aluminium	Without lock	ECST207426	857,00
		66,5		with lock	ECST207426L	887,00
 <p>width 1200 mm</p> <p>Hanging file frame for 2 rows of files</p> <p>one-way lock available</p>	<p>Cabinet with shutter door left-handed</p> <p>- 2x hanging file frames</p> <p>- 4x crossbars</p> <p>in colour: black</p> <p>shutter colour finishings:</p> <p>- black</p> <p>- aluminium</p>	66,4	black	without lock	ECST2L7425	829,00
		66,5		with lock	ECST2L7425L	859,00
		66,4	aluminium	without lock	ECST2L7426	857,00
		66,5		with lock	ECST2L7426L	887,00

Dimensions are stated in millimetres. The products weight allowance is 5%.

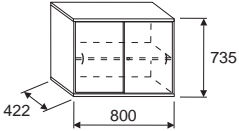
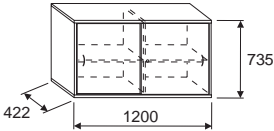
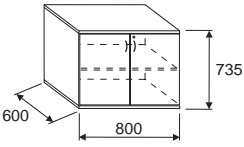
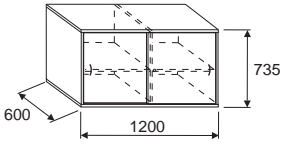
Schema	Description	Weight	Product variant	Art. No.	Price
CABINET WITH SLIDING DOOR 800 mm		Kg			EUR
	Cabinet with sliding door	35,5	without lock	ECM0748	189,00
	- one-way lock available	35,6	with lock	ECM0748L	205,00
CABINET WITH SLIDING DOOR 1200 mm					
	Cabinet with sliding door	56,4	without lock	ECM0742	219,00
	- one-way lock available	56,5	with lock	ECM0742L	236,00
CABINET UNDER THE COPIER 800 mm					
	Cabinet with Door to be placed under the copier	46,0	without lock	ECD20748	198,00
	- one-way lock available	46,1	with lock	ECD20748L	214,00
CABINET UNDER THE COPIER 1200 mm					
	Cabinet with sliding door to be placed under the copier	73,8	without lock	ECM20742	249,00
	- one-way lock available	73,9	with lock	ECM20742L	269,00

Dimensions are stated in millimetres. The products weight allowance is + 5%.

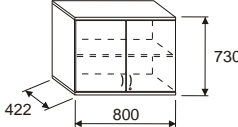
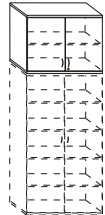
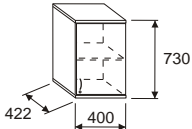
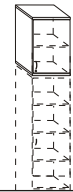
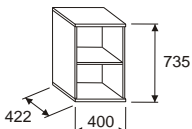
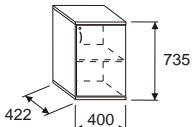
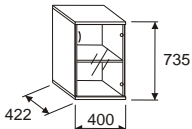
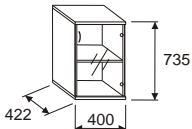
Schema	Description	Weight	Products variant	Art. No.	Price
EXTENSION CABINETS width 800 mm					
	Extension cabinet with door	Kg			EUR
	- one-way lock available	34,3	without lock	ECAD0748	169,-
		34,4	with lock	ECAD0748L	187,-
Width 400 mm					
	Extension cabinet with door	20,3	without lock	ECAD0744	109,-
	- one-way lock available	20,4	with lock	ECAD0744L	125,-
					
CABINET OPEN Width 400 mm					
	Cabinet open with shelves	16,8		ECO0744	85,-
CABINET WITH DOOR					
	Cabinet with door	20,4	without lock	ECD0744	115,-
	- one-way lock available	20,5	with lock	ECD0744L	125,-
					
CABINET WITH GLASS DOOR					
	Cabinet with glass door	20,3		ECG0744	157,-

Dimensions are stated in millimetres. The products weight allowance is 5%.

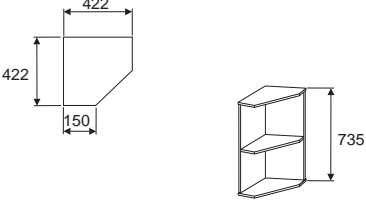
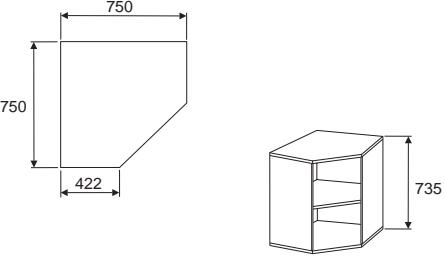
Schema	Description	Weight	Art. No.	Price
CORNER CABINET outer 	Corner cabinet outer 1x shelf	Kg 13,9	ECC0744	EUR 149,00
inner 	Corner cabinet inner 1x shelf	42,0	ECC0748	249,00

Dimensions are stated in millimetres. The products weight allowance is 5%.

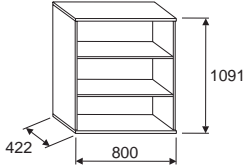
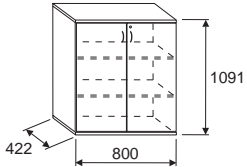
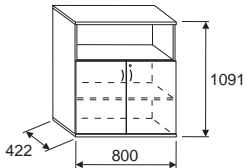
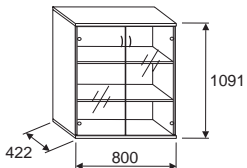
Schema	Description	Weight	Product variant	Art. No.	Price
CABINET OPEN width 800 mm		Kg			EUR
	Cabinet open with shelves	36,8		ECO1098	135,00
	CABINET WITH DOOR				
	Cabinet with door				
	- one-way lock available	47,9	without lock	ECD1098	206,00
		48,0	with lock	ECD1098L	219,00
CABINET COMBINED					
	Cabinet combined				
	- door/open element	44,8	without lock	ECDO109821	193,00
	- one-way lock available	44,9	with lock	ECDO109821L	209,00
CABINET WITH GLASS DOOR					
	Cabinet with glass door	47,6		ECG1098	219,00

Dimensions are stated in millimetres. The products weight allowance is 5%.

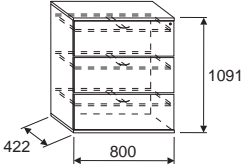
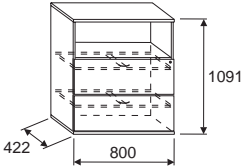
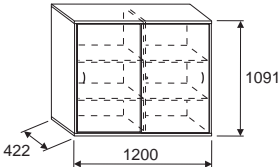
Schema	Description	Weight	Product variant	Art. No.	Price
CABINET WITH HANGING FILE FRAME					
HANGING FILE FRAMES WITH THE FRONT PANELS					
	Cabinet with hanging file frames				
	- 3 hanging file frames	56,5	without lock	ECR1098	519,00
	- central locking available	56,7	with lock	ECR1098L	569,00
CABINET WITH HANGING FILE FRAME - COMBINED					
HANGING FILE FRAMES WITH THE FRONT PANELS					
	Cabinet with hanging file frames				
	- 2 hanging file frames	51,3	without lock	ECRO109821	397,00
	- open element	51,5	with lock	ECRO109821L	439,00
	- central locking available				
CABINET WITH SLIDING DOOR 1200 mm					
	Cabinet with sliding door				
	- one-way lock available	80,0	Without lock	ECM1092	256,00
		80,1	with lock	ECM1092L	274,00

WARNING:

The hanging file frames are not equipped with the antitilt device and therefore it's necessary to secure the cabinet against possible tilt, preferably fixing it to the wall.

Dimensions are stated in millimetres. The products weight allowance is 5%.

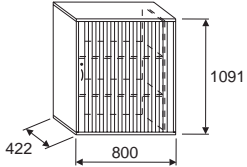
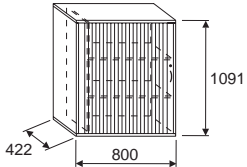
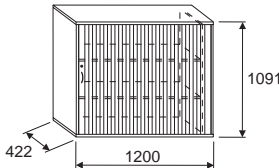
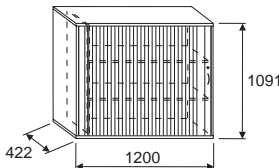
Schema	Description	Weight	Product variant	Art. No.	Price
CABINET WITH SHUTTER DOOR width 800 mm		Kg	Shutter door colour		EUR
	Cabinet with shutter door, right-handed	52,8	black	without lock	ECS10985 299,00
	shutter colour finishings:	52,9		with lock	ECS10985L 329,00
	- black	52,8	aluminium	without lock	ECS10986 328,00
	- aluminium	52,9		with lock	ECS10986L 358,00
- one-way lock available					
	Cabinet with shutter door, left-handed	52,8	black	without lock	ECSL0985 299,00
	shutter colour finishings:	52,9		with lock	ECSL0985L 329,00
	- black	52,8	aluminium	without lock	ECSL0986 328,00
	- aluminium	52,9		with lock	ECSL0986L 358,00
- one-way lock available					
width 1200 mm					
	Cabinet with shutter door, right-handed	72,8	black	without lock	ECS10925 374,00
	shutter colour finishings:	72,9		with lock	ECS10925L 404,00
	- black	72,8	aluminium	Without lock	ECS10926 399,00
	- aluminium	72,9		with lock	ECS10926L 429,00
- one-way lock available					
	Cabinet with shutter door, left-handed	72,8	black	without lock	ECSL0925 374,00
	shutter colour finishings:	72,9		with lock	ECSL0925L 404,00
	- black	72,8	aluminium	Without lock	ECSL0926 399,00
	- aluminium	72,9		with lock	ECSL0926L 429,00
- one-way lock available					

Dimensions are stated in millimetres. The products weight allowance is 5%.

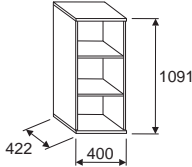
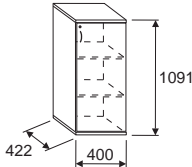
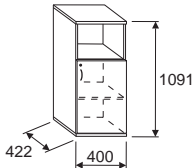
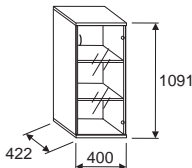
Schema	Description	Weight	Product variant	Art. No.	Price
CABINET OPEN width 400 mm		Kg			EUR
	Cabinet open with shelves	23,1		ECO1094	109,00
	CABINET WITH DOOR				
	Cabinet with door				
	- one-way lock available	28,6	Without lock	ECD1094	148,00
		28,7	with lock	ECD1094L	164,00
CABINET COMBINED					
	Cabinet combined				
	- door/open element	26,6	without lock	ECDO109421	139,00
	- one-way lock available	26,7	with lock	ECDO109421L	157,00
CABINET WITH GLASS DOOR					
	Cabinet with glass door	28,4		ECG1094	199,00

Dimensions are stated in millimetres. The products weight allowance is 5%.

Schema	Description	Weight	Art. No.	Price
<p>CORNER CABINETS outer</p>	<p>Corner cabinet outer 2x shelves</p>	<p>Kg 19,1</p>	<p>ECC1094</p>	<p>EUR 168,00</p>
<p>inner</p>	<p>Corner cabinet inner 2x shelves</p>	<p> 57,2</p>	<p>ECC1098</p>	<p> 279,00</p>

Dimensions are stated in millimetres. The products weight allowance is 5%.

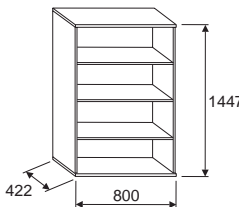
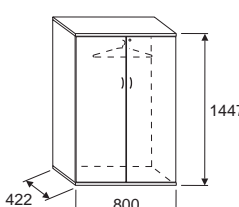
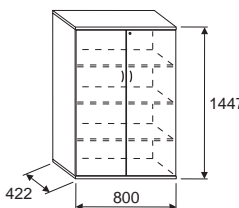
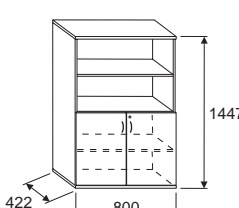
Schema	Description	Weight	Product variant	Art. No.	Price
CABINET OPEN width 800 mm		Kg			EUR
	Cabinet open with shelves	46,6		ECO1458	168,00
WARDROBE WITH DOOR					
	Wardrobe with door	49,0	without lock	ECW1458	227,00
	- equipped with an extractable bar for coat hangers - one-way lock available	49,1	with lock	ECW1458L	239,00
CABINET WITH DOOR					
	Cabinet with door	61,7	without lock	ECD1458	249,00
	- one-way lock available	61,8	with lock	ECD1458L	265,00
CABINET COMBINED					
	Cabinet combined	54,1	without lock	ECDO145822	226,00
	- door/open element - one-way lock available	54,2	with lock	ECDO145822L	239,00

Dimensions are stated in millimetres. The products weight allowance is 5%.

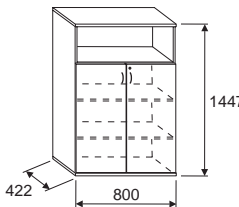
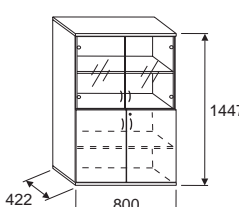
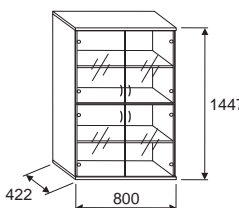
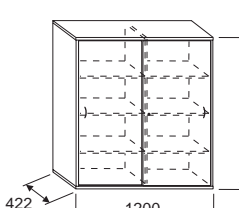
Schema	Description	Weight	Product variant	Art. No.	Price
CABINETS COMBINED width 800 mm		Kg			EUR
	Cabinet combined				
	- door/open element	57,9	without lock	ECDO145831	239,00
	- one-way lock available	58,0	with lock	ECDO145831L	256,00
	Cabinet combined				
	- door/glass door	61,4	without lock	ECDG145822	305,00
	- one-way lock available	61,5	with lock	ECDG145822L	319,00
CABINET WITH GLASS DOOR					
	Cabinet with glass door				
	glass door/glass door	61,4		ECGG145822	329,00
CABINET WITH SLIDING DOOR 1200 mm					
	Cabinet with sliding door				
	- one-way lock available	99,5	without lock	ECM1452	295,00
		99,6	with lock	ECM1452L	309,00

**HANGING FILE FRAMES
WITH THE FRONT PANELS**

Dimensions are stated in millimetres. The products weight allowance is 5%.

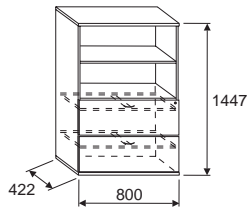
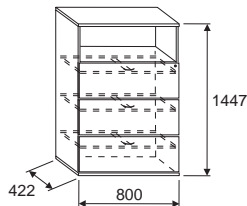
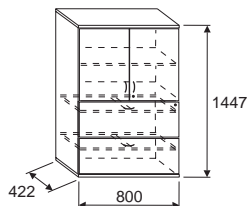
Schema	Description	Weight	Product variant	Art. No.	Price
CABINETS COMBINED		Kg			EUR
	Cabinet with hanging file frames				
	- 2 hanging file frames	61,1	without lock	ECRO145822	429,00
	- 2 open elements	61,3	with lock	ECRO145822L	469,00
	- central locking available				
	Cabinet with hanging file frames				
	- 3 hanging file frames	66,3	without lock	ECRO145831	555,00
	- open element	66,5	with lock	ECRO145831L	599,00
	- central locking available				
	Cabinet with hanging file frames				
	- 2 hanging file frames	68,6	without lock	ECRD145822	487,00
	- door	68,9	with lock	ECRD145822L	546,00
	- central locking available				
	- one-way lock available for the door				

WARNING: The hanging file frames are not equipped with the antitilt device and therefore it's necessary to secure the cabinet against possible tilt, preferably fixing it to the wall.

Dimensions are stated in millimetres. The products weight allowance is 5%.

Schema	Description	Weight	Product variant	Art. No.	Price	
CABINET WITH SHUTTER DOOR width 800 mm						
	Cabinet with shutter door, right-handed shutter colour finishings: - black - aluminium - one-way lock available	Kg	Shutter door colour		EUR	
		67,7	black	Without lock	ECS14585	377,00
		67,8		with lock	ECS14585L	407,00
		67,7	aluminium	Without lock	ECS14586	418,00
67,8	with lock	ECS14586L		448,00		
	Cabinet with shutter door, left-handed shutter colour finishings: - black - aluminium - one-way lock available	67,7	black	Without lock	ECSL4585	377,00
		67,8		with lock	ECSL4585L	407,00
		67,7	aluminium	Without lock	ECSL4586	418,00
		67,8		with lock	ECSL4586L	448,00
width 1200 mm						
	Cabinet with shutter door, right-handed shutter colour finishings: - black - aluminium - one-way lock available	89,2	black	without lock	ECS14525	468,00
		89,3		with lock	ECS14525L	497,00
		89,2	aluminium	Without lock	ECS14526	496,00
		89,3		with lock	ECS14526L	526,00
	Cabinet with shutter door, left-handed shutter colour finishings: - black - aluminium - one-way lock available	89,2	black	without lock	ECSL4525	468,00
		89,3		with lock	ECSL4525L	497,00
		89,2	aluminium	Without lock	ECSL4526	496,00
		89,3		with lock	ECSL4526L	526,00

Dimensions are stated in millimetres. The products weight allowance is 5%.

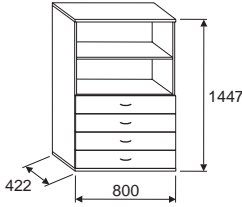
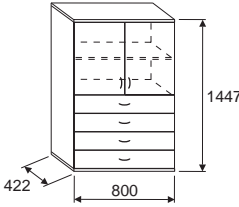
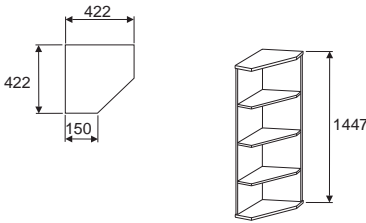
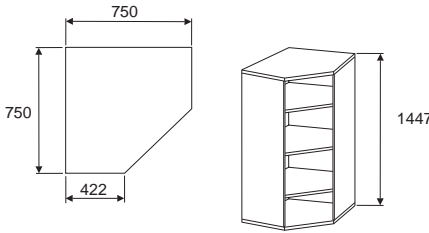
Schema	Description	Weight	Art. No.	Price
CABINETS COMBINED width 800 mm		Kg		EUR
	Cabinet combined - 4 drawers - open element	69,3	EC	375,00
	Cabinet combined - 4 drawers - door	76,8	EC	434,00
CORNER CABINETS outer				
	Corner cabinet outer 3x shelves	24,4	ECC1454	184,00
inner				
	Corner cabinet inner 3x shelves	72,2	ECC1458	325,00

Dimensions are stated in millimetres. The products weight allowance is \pm 5%.

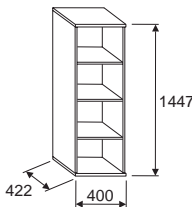
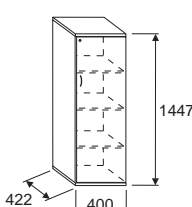
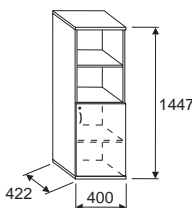
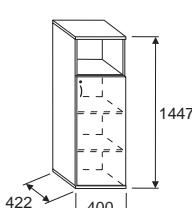
Schema	Description	Weight	Product variant	Art. No.	Price
CABINET OPEN width 400 mm		Kg			EUR
	Cabinet open with shelves	29,4		ECO1454	129,00
	CABINET WITH DOOR				
	Cabinet with door				
	- one-way lock available	36,9	Without lock	ECD1454	173,00
		37,0	with lock	ECD1454L	189,00
CABINETS COMBINED					
	Cabinet combined				
	- door/open element	32,9	without lock	ECDO145422	159,00
	- one-way lock available	33,0	with lock	ECDO145422L	178,00
	Cabinet combined				
	- door/open element	35,0	without lock	ECDO145431	169,00
	- one-way lock available	35,1	with lock	ECDO145431L	185,00

Dimensions are stated in millimetres. The products weight allowance is \pm 5%.

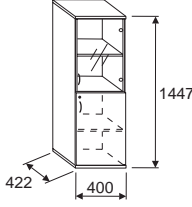
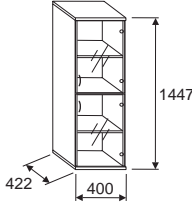
Schema	Description	Weight	Product variant	Art. No.	Price
CABINET COMBINED width 400 mm		Kg			EUR
	Cabinet combined				
	- door/glass door	36,4	without lock	ECDG145422	216,00
	- one-way lock available for lower door	36,5	with lock	ECDG145422L	229,00
CABINET WITH GLASS DOOR					
	Cabinet with glass door				
	- glass door/glass door	36,4		ECGG145422	217,00

Dimensions are stated in millimetres. The products weight allowance is 5%.

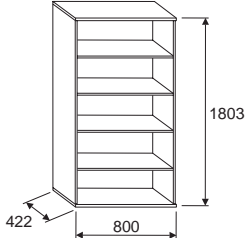
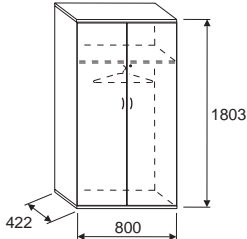
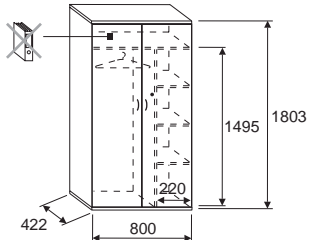
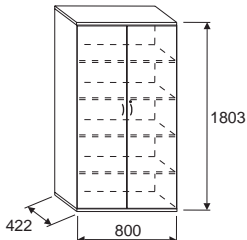
Schema	Description	Weight	Product variant	Art. No.	Price
CABINET OPEN width 800 mm		Kg			EUR
	Cabinet open with shelves	56,3		ECO1808	187,00
WARDROBES WITH DOOR					
	Wardrobe with door				
	- equipped with an extractable bar for coat hangers	63,5	Without lock	ECW1808	259,00
	- one-way lock available	63,6	with lock	ECW1808L	277,00
	Wardrobe with door partition, shelves				
	- equipped with an extractable bar for coat hangers	74,7	Without lock	ECWS1808	307,00
	- one-way lock available	74,8	with lock	ECWS1808L	323,00
CABINET WITH DOOR					
	Cabinet with door				
	- one-way lock available	75,2	Without lock	ECD1808	279,00
		75,3	with lock	ECD1808L	298,00

Dimensions are stated in millimetres. The products weight allowance is 5%.

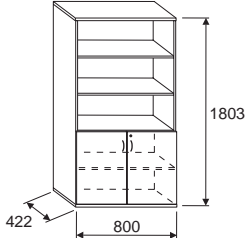
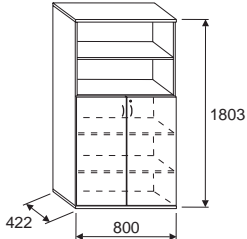
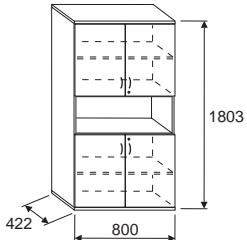
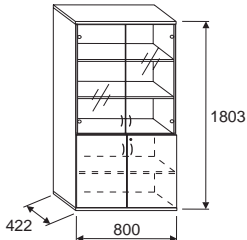
Schema	Description	Weight	Product variant	Art. No.	Price
CABINETS COMBINED		Kg			EUR
	Cabinet combined				
	- door/open element	63,9	Without lock	ECDO180823	246,00
	- one-way lock available	64,0	with lock	ECDO180823L	259,00
	Cabinet combined				
	- door/open element	67,7	Without lock	ECDO180832	259,00
	- one-way lock available	67,8	with lock	ECDO180832L	277,00
	Cabinet combined				
	- door/open element/ door	71,5	without lock	ECDOD1808212	299,00
	- one-way lock available	71,7	with lock	ECDOD1808212L	329,00
	Cabinet combined				
	- door/glass door	74,8	without lock	ECDG180823	339,00
	- one-way lock available	74,9	with lock	ECDG180823L	358,00

Dimensions are stated in millimetres. The products weight allowance is 5%.

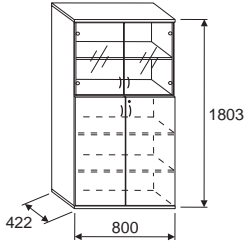
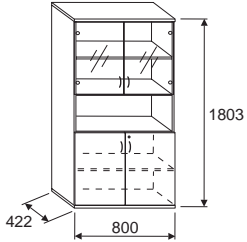
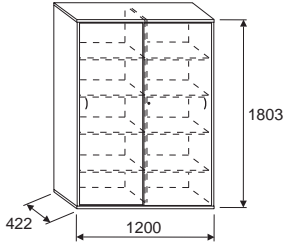
Schema	Description	Weight	Product variant	Art. No.	Price
CABINETS COMBINED					
	Cabinet combined door/glass door - one way lock available	Kg			EUR
		74,8	without lock	ECDG180832	339,00
		74,9	with lock	ECDG180832L	356,00
<hr/>					
	Cabinet combined door/open element/glass door - one way lock available	71,0	Without lock	ECDOG1808212	326,00
		71,1	with lock	ECDOG1808212L	339,00
<hr/>					
CABINET WITH SLIDING DOOR 1200 mm					
	Cabinet with sliding door - one-way lock available	124,5	Without lock	ECM1802	404,00
		124,6	with lock	ECM1802L	419,00

Dimensions are stated in millimetres. The products weight allowance is 5%.

Schema	Description	Weight	Product variant	Art. No.	Price	
CABINET WITH SHUTTER DOOR width 800 mm						
	Cabinet with shutter door, right-handed shutter colour finishings: - black - aluminium	83,2	black	Without lock	ECS18085	479,00
		83,3		with lock	ECS18085L	509,00
	- one-way lock available	83,2	aluminium	Without lock	ECS18086	516,00
		83,3		with lock	ECS18086L	546,00
	Cabinet with shutter door, left-handed shutter colour finishings: - black - aluminium	83,2	black	Without lock	ECSL8085	479,00
		83,3		with lock	ECSL8085L	509,00
	- one-way lock available	83,2	aluminium	Without lock	ECSL8086	516,00
		83,3		with lock	ECSL8086L	546,00
width 1200 mm						
	Cabinet with shutter door, right-handed shutter colour finishings: - black - aluminium	110,9	black	Without lock	ECS18025	529,00
		111,0		with lock	ECS18025L	559,00
	- one-way lock available	110,9	aluminium	Without lock	ECS18026	569,00
		111,0		with lock	ECS18026L	599,00
	Cabinet with shutter door, left-handed shutter colour finishings: - black - aluminium	110,9	black	Without lock	ECSL8025	529,00
		111,0		with lock	ECSL8025L	559,00
	- one-way lock available	110,9	aluminium	Without lock	ECSL8026	569,00
		111,0		with lock	ECSL8026L	599,00

HANGING FILE FRAMES
WITH THE FRONT PANELS

Dimensions are stated in millimetres. The products weight allowance is 5%.

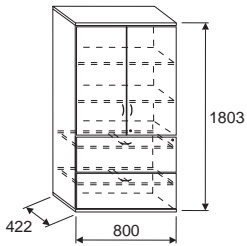
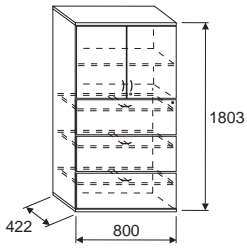
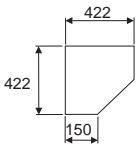
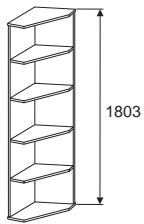
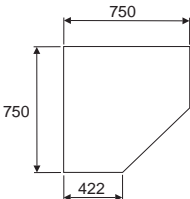
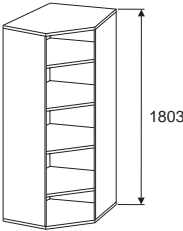
Schema	Description	Weight	Product variant	Art. No.	Price
CABINETS COMBINED					
	Cabinet combined with hanging file frames - 2 hanging file frames - door - one way lock available	81,9	without lock	ECRD180823	519,00
		82,2	with lock	ECRD180823L	579,00
	Cabinet combined with hanging file frames - 3 hanging file frames - door - one-way lock available	83,6	without lock	ECRD180832	629,00
		83,9	with lock	ECRD180832L	695,00
CORNER CABINETS					
outer					
 	Corner cabinet outer 4x shelves	29,6		ECC1804	199,00
inner					
 	Corner cabinet inner 4x shelves	87,1		ECC1808	367,00

WARNING: The hanging file frames are not equipped with the antitilt device and therefore it's necessary to secure the cabinet against possible tilt, preferably fixing it to the wall.

HANGING FILE FRAMES
WITH THE FRONT PANELS

Dimensions are stated in millimetres. The products weight allowance is 5%.

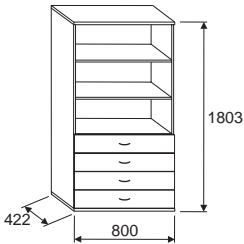
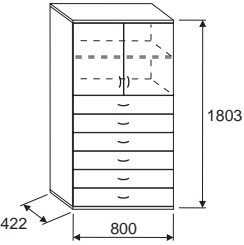
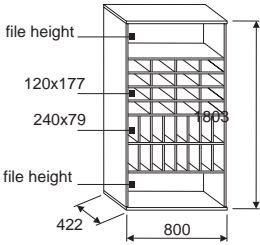
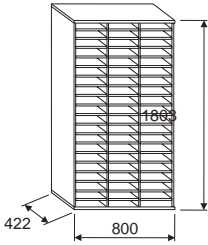
Schema	Description	Weight	Art. No.	Price
CABINETS COMBINED				
	Cabinet combined - 4 drawers - open element	Kg 79,0	EC	EUR 395,00
	Cabinet combined - 6 drawers - door	95,8	EC	569,00
CABINET FOR LETTERS AND OTHER CORRESPONDENCE				
	Cabinet for letters and other correspondence - pigeon-holes for different sizes of consignments - file shelves	98,6	ECDB1808T	404,00
	Cabinet with 60 pigeon-holes - pigeon-holes for different sizes of consignments	128,0	ECDB180860	559,00

WARNING: The hanging file frames are not equipped with the antitilt device and therefore it's necessary to secure the cabinet against possible tilt, preferably fixing it to the wall.

Dimensions are stated in millimetres. The products weight allowance is \pm 5%.

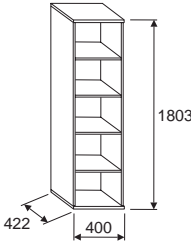
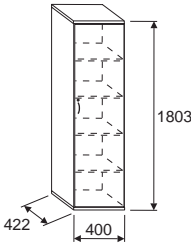
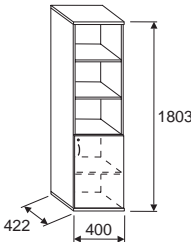
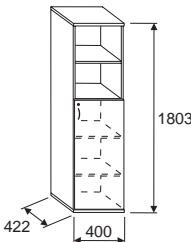
Schema	Description	Weight	Product variant	Art. No.	Price
CABINET OPEN width 400 mm		Kg			EUR
	Cabinet open with shelves	35,7		ECO1804	159,00
CABINET WITH DOOR					
	Cabinet with door				
	- one-way lock available	45,1	Without lock	ECD1804	208,00
		45,2	with lock	ECD1804L	224,00
CABINET COMBINED					
	Cabinet combined				
	- door/open element	39,2	without lock	ECDO180423	189,00
	- one-way lock available	39,3	with lock	ECDO180423L	219,00
	Cabinet combined				
	- door/open element	41,3	without lock	ECDO180432	167,00
	- one-way lock available	41,4	with lock	ECDO180432L	209,00

Dimensions are stated in millimetres. The products weight allowance is \pm 5%.

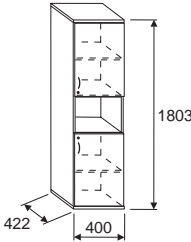
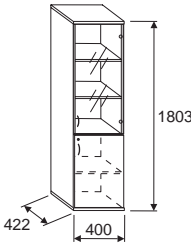
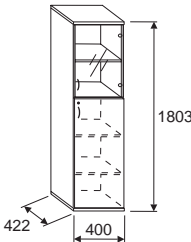
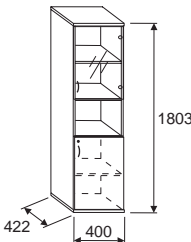
Schema	Description	Weight	Product variant	Art. No.	Price
	Cabinet combined				
	- door/open element/ door	42,7	without lock	ECDOD1804212	216,00
	- one-way lock available	42,9	with lock	ECDOD1804212L	247,00
	Cabinet combined				
	- door/glass door	44,5	without lock	ECDG180423	233,00
	- one-way lock available	44,6	with lock	ECDG180423L	249,00
	Cabinet combined				
	- door/glass door	44,5	without lock	ECDG180432	239,00
	- one-way lock available	44,6	with lock	ECDG180432L	255,00
	Cabinet combined				
	- door/open element/ glass door	42,7	without lock	ECDOG1804212	233,00
	- one-way lock available	42,8	with lock	ECDOG1804212L	248,00

Dimensions are stated in millimetres. The products weight allowance is 5%.

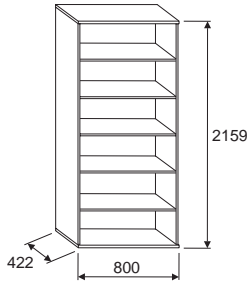
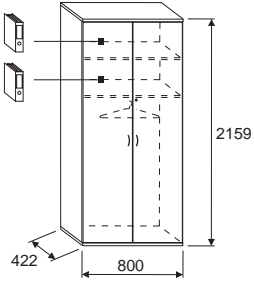
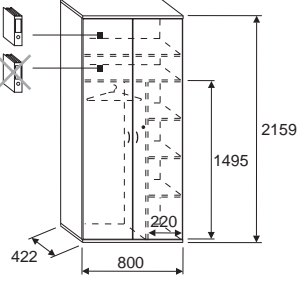
Schema	Description	Weight	Product variant	Art. No.	Price
<p>CABINET OPEN width 800 mm</p> 	Cabinet open with shelves	Kg			EUR
		66,2		ECO2158	256,00
<p>WARDROBE WITH DOOR</p> 	<p>Wardrobe with door</p> <ul style="list-style-type: none"> - equipped with an extractable bar for coat hangers - one-way lock available 	76,6	without lock	ECW2158	319,00
		76,7	with lock	ECW2158L	336,00
	<p>Wardrobe with door partition, shelves</p> <ul style="list-style-type: none"> - equipped with an extractable bar for coat hangers - one-way lock available 	87,8	Without lock	ECWS2158	368,00
		87,9	with lock	ECWS2158L	384,00

Dimensions are stated in millimetres. The products weight allowance is 5%.

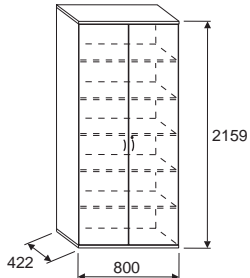
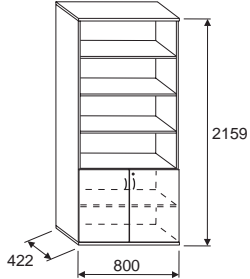
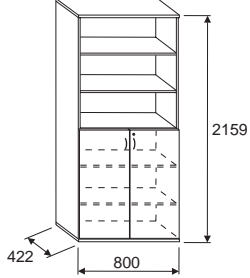
Schema	Description	Weight	Product variant	Art. No.	Price
CABINET WITH DOOR		Kg			EUR
	Cabinet with door				
	- one-way lock available				
		88,9	Without lock	ECD2158	359,00
		89,0	with lock	ECD2158L	375,00
CABINET COMBINED					
	Cabinet combined				
	- door/open element				
	- one-way lock available	73,8	Without lock	ECDO215824	314,00
		73,9	with lock	ECDO215824L	329,00
	Cabinet combined				
	- door/open element				
	- one-way lock available	77,5	Without lock	ECDO215833	328,00
		77,6	with lock	ECDO215833L	344,00

Dimensions are stated in millimetres. The products weight allowance is \pm 5%.

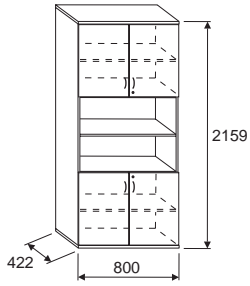
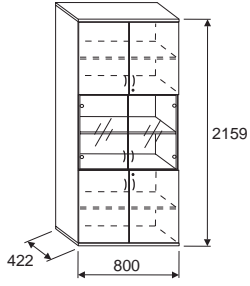
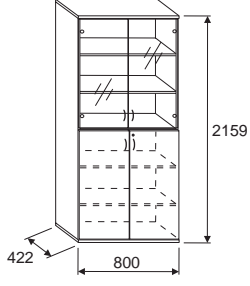
Schema	Description	Weight	Product variant	Art. No.	Price
CABINET COMBINED		Kg			EUR
	Cabinet combined				
	- door/open element/ door				
	- one-way lock available	81,3	Without lock	ECDOD2158222	367,00
		81,4	with lock	ECDOD2158222L	399,00
	Cabinet combined				
	- door/glass door/ door				
	- one-way lock available	94,8	without lock	ECDGD2158222	447,00
		95,0	with lock	ECDGD2158222L	479,00
	Cabinet combined				
	- door/glass door				
	- one-way lock available	88,5	Without lock	ECDG215833	423,00
		88,6	with lock	ECDG215833L	439,00

Dimension are stated in millimetres. The products weight allowance is 5%.

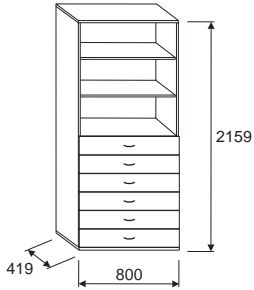
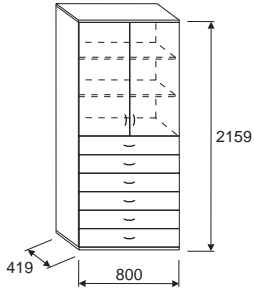
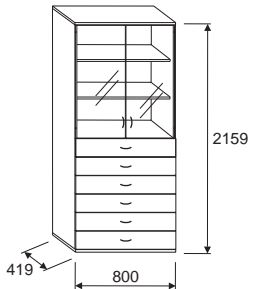
Schema	Description	Weight	Product variant	Art. No.	Price
CABINETS COMBINED					
	Cabinet combined 6 drawers/ open element	Kg 98,2	without lock	ECZO215863	569,00 EUR
	Cabinet combined 6 drawers/door	109,5	without lock	ECZD215863	639,00
	Cabinet combined 6 drawers/ glass door	109,2	without lock	ECZG215863	665,00

Dimensions are stated in millimetres. The products weight allowance is 5%.

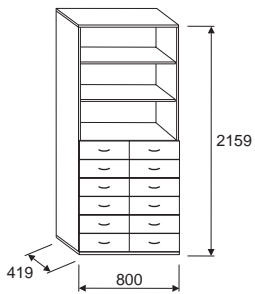
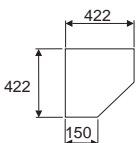
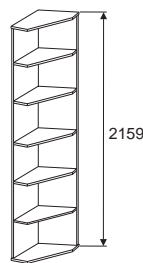
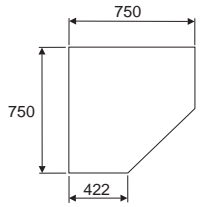
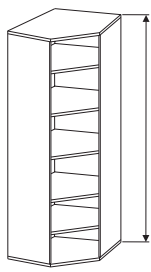
Schema	Description	Weight	Product variant	Art. No.	Price
CABINET COMBINED		Kg			EUR
	Cabinet combined 12 drawers/ open element	109,3	Without lock	ECZO2158123	813,00
CORNER CABINETS	outer				
 	Corner cabinet outer 5 shelves	34,8		ECC2154	214,00
	inner				
 	Corner cabinet outer 5 shelves	102,2		ECC2158	399,00

**HANGING FILE FRAMES
WITH THE FRONT PANELS**

Dimensions are stated in millimetres. The products weight allowance is 5%.

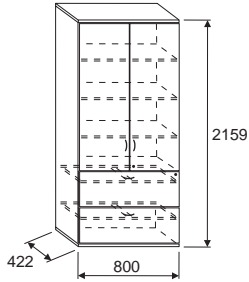
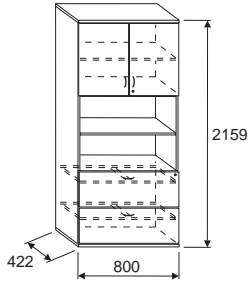
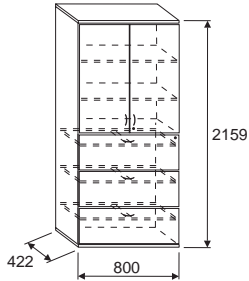
Schema	Description	Weight	Product variant	Art. No.	Price
CABINET COMBINED					
	Cabinet with hanging file frames				
	- 2 hanging file frames - door	95,8	without lock	ECRD215824	598,00
	- central locking available - one-way lock available for the door	96,1	with lock	ECRD215824L	657,00
	Cabinet with hanging file frames				
	- 2 hanging file frames - open element - door	88,0	without lock	ECROD2158222	575,00
	- central locking available - one-way lock available for the door	88,3	with lock	ECROD2158222L	634,00
	Cabinet with hanging file frames				
	- 3 hanging file frames - door	97,2	without lock	ECRD215833	724,00
	- central locking available - one-way lock available for the door	97,5	with lock	ECRD215833L	777,00

WARNING: The hanging file frames are not equipped with the antitilt device and therefore it's necessary to secure the cabinet against possible tilt, preferably fixing it to the wall.

HANGING FILE FRAMES
WITH THE FRONT PANELS

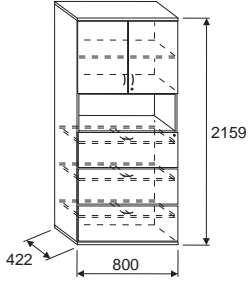
Schema	Description	Weight	Product variant	Art. No.	Price
	Cabinet with hanging file frames				
	<ul style="list-style-type: none"> - 3 hanging file frames - open element - door - central locking available - one-way lock available for the door 	<ul style="list-style-type: none"> 93,5 93,8 	<ul style="list-style-type: none"> without lock with lock 	<ul style="list-style-type: none"> ECROD2158312 ECROD2158312L 	<ul style="list-style-type: none"> 699,00 763,00

WARNING: The hanging file frames are not equipped with the antitilt device and therefore it's necessary to secure the cabinet against possible tilt, preferably fixing it to the wall.

Dimensions are stated in millimetres. The products weight allowance is 5%.

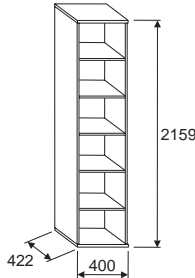
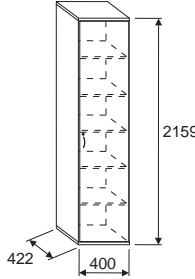
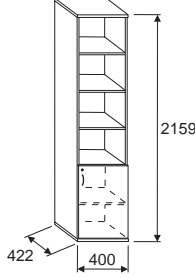
Schema	Description	Weight	Product variant	Art. No.	Price
CABINET OPEN width 400 mm		Kg			EUR
	Cabinet open with shelves	42,1		ECO2154	179,00
	CABINET WITH DOOR				
	Cabinet with door				
	- one-way lock available	53,3	Without lock	ECD2154	229,00
		53,4	with lock	ECD2154L	246,00
CABINET COMBINED					
	Cabinet combined				
	- door/open element				
	- one-way lock available	45,6	without lock	ECDO215424	208,00
		45,7	with lock	ECDO215424L	224,00

Dimensions are stated in millimetres. The products weight allowance is ± 5%.

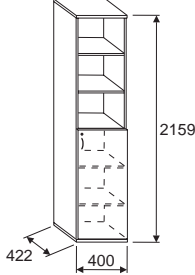
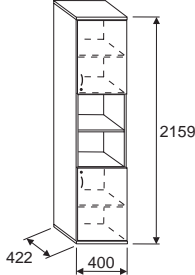
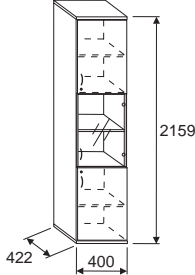
Schema	Description	Weight	Product variant	Art. No.	Price
CABINET COMBINED width 400 mm 	Cabinet combined	Kg			EUR
	- door/open element				
	- one-way lock available	47,6	without lock	ECDO215433	215,00
		47,7	with lock	ECDO215433L	229,00
	Cabinet combined				
	- door/open element/ door				
	- one-way lock available	49,1	without lock	ECDOD2154222	235,00
		49,3	with lock	ECDOD2154222L	266,00
	Cabinet combined				
	- door/glass door/ door				
	- one-way lock available	52,6	without lock	ECDGD2154222	276,00
		52,8	with lock	ECDGD2154222L	307,00

Dimensions are stated in millimetres. The products weight allowance is 5%.

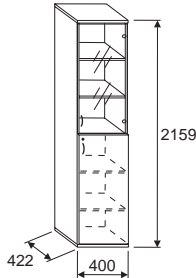
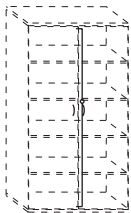
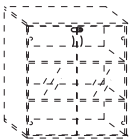
Schema	Description	Weight	Product variant	Art. No.	Price
CABINET COMBINED		Kg			EUR
	Cabinet combined				
	- door/glass door				
	- one-way lock available	53,3	without lock	ECDG215433	264,00
		53,4	with lock	ECDG215433L	279,00
TWO-WAY LOCK					
	Two-way lock locking the door to the bottom and the top of the carcass	0,5		LCD2	33,00
<p>Notice: To be used as accessory for cabinets without any lock. Has to be ordered simultaneously with the cabinet, it's not possible to install the lock additionally.</p>					
LOCK FOR GLASS DOOR					
	Lock for glass door				
	- one-way locking	0,2		LCG	29,00
<p>Notice: To be used as accessory for cabinets without any lock. Has to be ordered simultaneously with the cabinet, it's not possible to install the lock additionally.</p>					

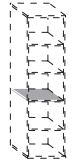
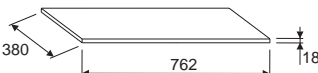
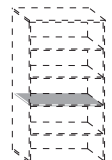
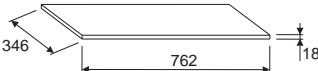
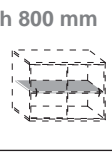
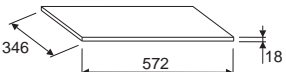
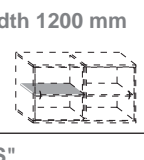
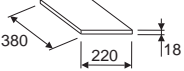
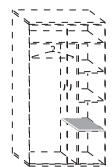
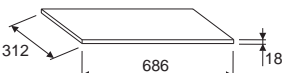
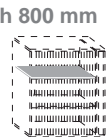

Dimensions are stated in millimetres. The products weight allowance is 5%.

Schema	Description	Weight	Product variant	Art. No.	Price
to be used for cabinets "ECO", "ECD" and combined					
 <p>width 400 mm</p> 	Additional shelf for cabinets width 400 mm:				
	- open	2,2	additional shelf	ESW04F4	10,00
	- with door	2,2	fixed shelf	ESW04M4	13,00
	- combined, including connecting fittings				
to be used for cabinets "ECM"					
 <p>width 800 mm</p> 	Additional shelf for cabinets width 800 mm:				
	- open	3,9	additional shelf	ESW08F4	14,00
	- with door	3,9	fixed shelf	ESW08M4	18,00
	- combined				
	- with hanging file frames, including connecting fittings				
to be used for cabinets "ECWS"					
 <p>width 800 mm</p> 	Additional shelf for cabinets width 800 mm:				
	- with sliding door, including connecting fittings	4,1	additional shelf	ESWM08F4	14,00
		4,1	fixed shelf	ESWM08M4	18,00
to be used for cabinets "ECWS"					
 <p>width 1200 mm</p> 	Additional shelf for cabinets width 1200 mm:				
	- with sliding door, including connecting fittings	2,8	additional shelf	ESWM12F4	13,00
		2,8	fixed shelf	ESWM12M4	16,00
to be used for cabinets "ECWS"					
 <p>width 220 mm</p> 	Additional shelf for wardrobe with a partition, including the shelf stabilizers	1,2	additional Shelf	ESWS02F4	9,00
to be used for cabinets "ECS"					
 <p>width 800 mm</p> 	Additional shelf for cabinets width 800 mm, including connecting fittings	2,9	additional shelf	ESW06F4	14,00
			2,9	fixed shelf	ESW06M4

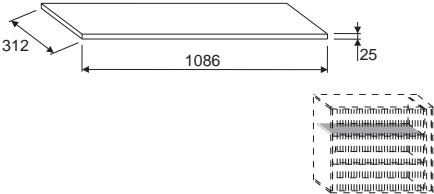
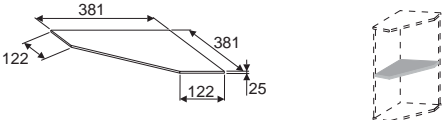
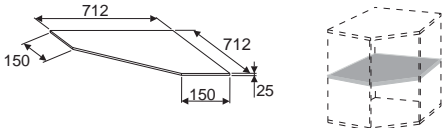
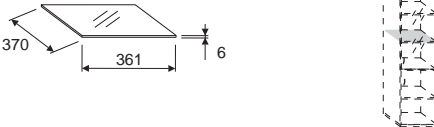
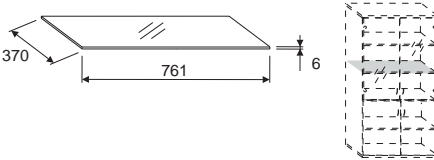
Dimensions are stated in millimetres. The products weight allowance is 5%.

Schema	Description	Weight	Product variant	Art. No.	Price
to be used for cabinets "ECS"					
<p>width 1200 mm</p> 	<p>Additional shelf for cabinets with shutter door width 1200 mm,</p> <p>- including connecting fittings</p>	4,6	additional shelf	ESW10F4	19,00
		4,6	fixed shelf	ESW10M4	22,00
to be used for cabinets "ECC"					
<p>width 422 mm</p> 	<p>Additional shelf for corner outer cabinets</p> <p>- including connecting fittings</p>	1,5	additional shelf	ESWC04F4	28,00
		1,5	fixed shelf	ESWC04M4	30,00
<p>width 750 mm</p> 	<p>Additional shelf for corner inner cabinets</p> <p>- including connecting fittings</p>	6,1	additional shelf	ESWC07F4	50,00
		6,1	fixed shelf	ESWC07M4	58,00
to be used for cabinets "ECO", "ECG" and combined					
<p>width 400 mm</p> 	<p>Glass shelf for cabinets width 400 mm,</p> <p>- including connecting fittings</p>	2,2	additional shelf	ESG04F4	18,00
<p>width 800 mm</p> 	<p>Glass shelf for cabinets width 800 mm,</p> <p>- including connecting fittings</p>	3,9	additional shelf	ESG08F4	32,00

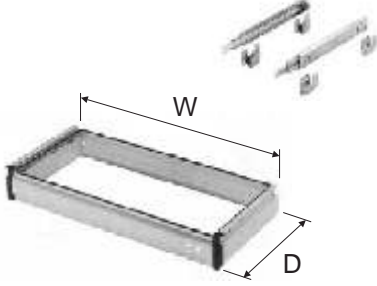
Dimensions are stated in millimetres. The products weight allowance is 5%.

Schema	Description	Weight Kg	Dimensions		Product variant	Art. No.	Price EUR
			W	D			
HANGING FILE FRAME							
 <p>Note: Hanging file frame has to be ordered together with the product.</p>	Hanging file frame including 1 set of runners						
	Frame in colour finishing black RAL 9005	5,5	762	380	without installing	TF0804	90,00
	FOR CABINETS: - open "ECO", "SCO" - with door "ECD", "SCD"... - combined "ECDO", "SCDO"...	5,5	762	380	installing in our production	TFM0804	104,00
CROSS BAR							
	Cross bar for hanging file frame Cross bar in colour finishing black RAL 9005	0,1				TFC04	6,00

Note: Hanging file frames are used as accessory for cabinets type Economic and Standard.



Hanging file frames

- enabling additional installing in our cabinets
- possible installation in our production (max. 3 hanging file frames in 1 cabinet)

Possibility of lengthwise or crosswise hanging the files



Information/warning max. number of used hanging file frames and fixing the cabinet to the wall (stick-on label)

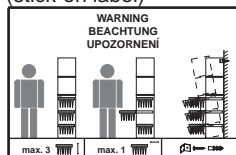

▼ Safety plastic corners



▼ Bull runners with 100% extension



WARNING:

The hanging file frames are not equipped with the antitilt device and therefore it's necessary to secure the cabinet against possible tilt, preferably fixing it to the wall.

MELAMINE FURNITURE
COLOUR FINISHINGS
DESK THICKNESS 18 mm

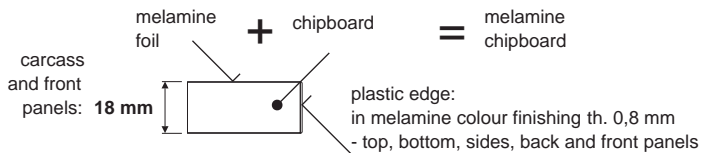

CARCASS COLOUR FINISHINGS

STANDARD COLOUR FINISHING

Delivery term of furniture in standard colour finishing is four weeks

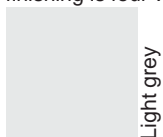

ADDITIONAL COLOUR FINISHING

Delivery term of furniture in additional colour finishing is six weeks or by agreement with the seller.

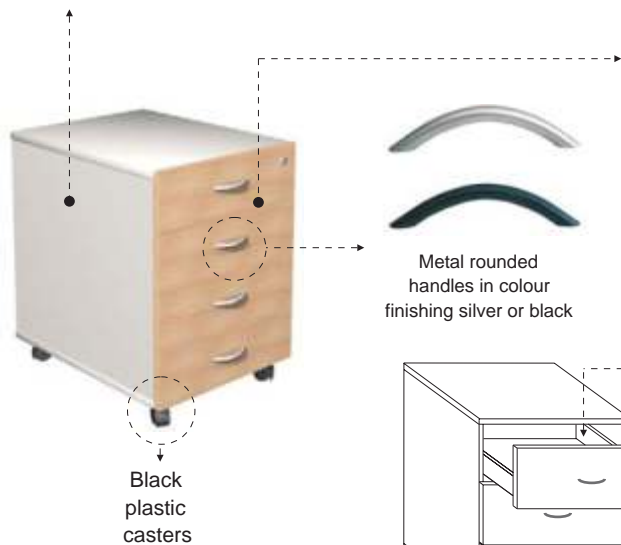

Furniture line Economic contains only basic types of pedestals.

DOOR COLOUR FINISHINGS

STANDARD COLOUR FINISHINGS

Delivery term of furniture in standard colour finishings is four weeks.



ADDITIONAL COLOUR FINISHING

Delivery term of furniture in additional colour finishings is six weeks or by agreement with the seller.

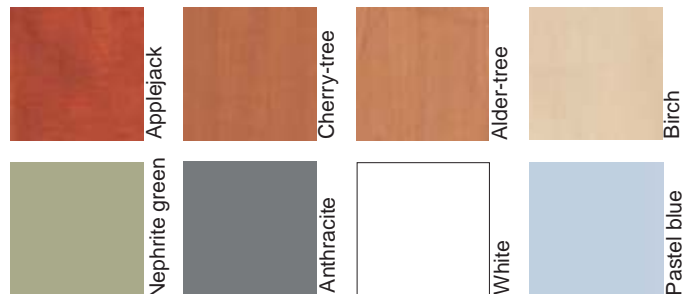

ACCESSORY
PLASTIC PEN TRAY
TO BE USED FOR ALL
TYPES OF PEDESTALS

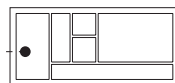

Häfele locks enabling the system of general key

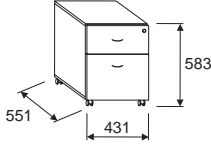
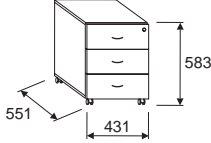
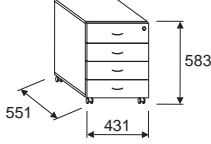

Dimensions are stated in millimetres. The products weight allowance is 5%.

Schema	Description	Weight	Art. No.	Price
MOBILE		Kg		EUR
	Mobile pedestal equipped with central locking - drawer - file drawer	25,5	SXM2	165,00
	Mobile pedestal equipped with central locking - 3 drawers	26,5	SXM3	169,00
	Mobile pedestal equipped with central locking - 4 drawers	27,9	SXM4	179,00

**MELAMINE FURNITURE
COLOUR FINISHINGS
FOR THICKNESS**

- 18 mm
- 25 mm

sides, front panels
and backs: 18 mm
top, bottom: 25 mm

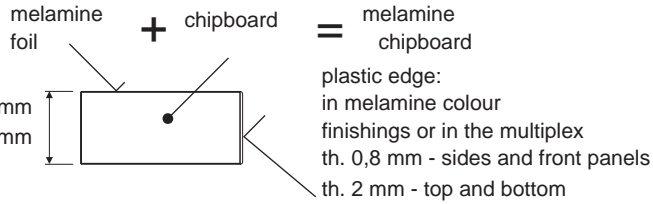

STANDARD COLOUR FINISHINGS

Delivery term of furniture in standard colour finishings is four weeks.



ADDITIONAL COLOUR FINISHINGS

Delivery term of furniture in additional colour finishings is six weeks or by agreement with the seller.



FRONT PANELS ADDITIONAL COLOUR FINISHINGS



Desk height pedestals
- depth 600 and 800 mm
- equipped with arresting elements for floor levelling



Metal rounded handles in colour finishing silver or black

ACCESSORY
PLASTIC PEN TRAY
TO BE USED FOR ALL
TYPES OF PEDESTALS

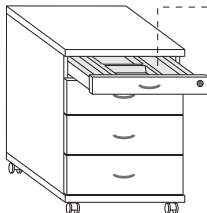
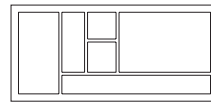

Top drawer
- individual pen tray

----- 75% extension
of drawers



Mobile pedestals
- equipped with
antitilt device

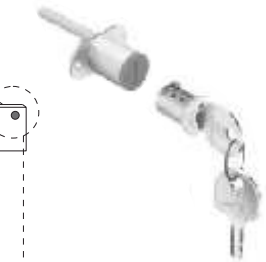
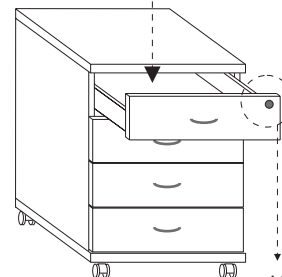

Häfele locks
enabling the system
of general key

Dimensions are stated in millimetres. The products weight allowance is 5%.

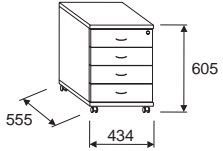
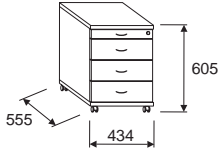
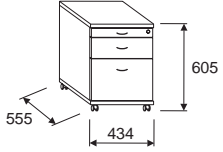
Schema	Description	Weight	Art. No.	Price
MOBILE		Kg		EUR
	Mobile pedestal equipped with central locking - 4 drawers	30,8	EXM9554	229,00
	Mobile pedestal equipped with central locking - 3 drawers - pen drawer	30,4	EXM0553	239,00
	Mobile pedestal equipped with central locking - pen drawer - drawer - file drawer	29,7	EXM0552	229,00

Dimensions are stated in millimetres. The products weight allowance is 5%.

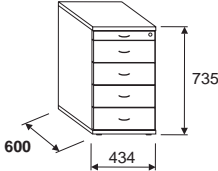
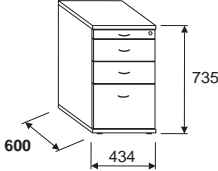
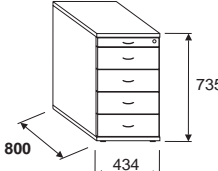
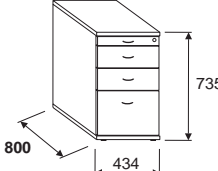
Schema	Description	Weight	Art. No.	Price
DESK HEIGHT		Kg		EUR
	Desk height pedestal equipped with central locking - pen drawer - 4 drawers	37,4	EXS0604	256,00
	Desk height pedestal equipped with central locking - pen drawer - 2 drawers - file drawer	36,5	EXS0603	259,00
	Desk height pedestal equipped with central locking - pen drawer - 4 drawers	44,8	EXS0804	266,00
	Desk height pedestal equipped with central locking - pen drawer - 2 drawers - file drawer	43,9	EXS0803	269,00

Dimensions are stated in millimetres. The products weight allowance is 5%.

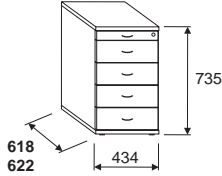
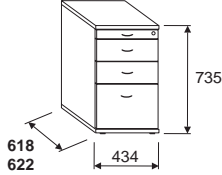
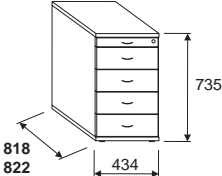
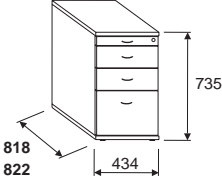
Schema	Description	Weight	Depth	Partition	Art. No.	Price
DESK HEIGHT		Kg	mm	wall		EUR
	Desk height pedestal for tables with a partition wall	37,6	618	Panel	EXS1604	255,00
	- central locking - pen tray - 4 drawers	37,7	622	Fabric	EXS2604	255,00
	Desk height pedestal for tables with a partition wall	36,7	618	Panel	EXS1603	259,00
	- central locking - pen tray - 2 drawers - file drawer	36,8	622	Fabric	EXS2603	259,00
	Desk height pedestal for tables with a partition wall	45,0	818	Panel	EXS1804	266,00
	- central locking - pen tray - 4 drawers	45,1	822	Fabric	EXS2804	266,00
	Desk height pedestal for tables with a partition wall	44,1	818	Panel	EXS1803	269,00
	- central locking - pen tray - 2 drawers - file drawer	44,2	822	Fabric	EXS2803	269,00

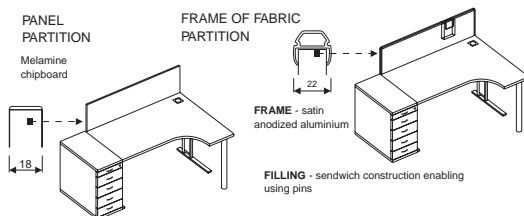

Dimensions are stated in millimetres. The products weight allowance is 5%.

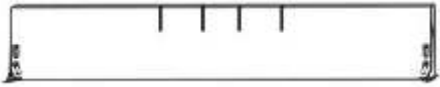
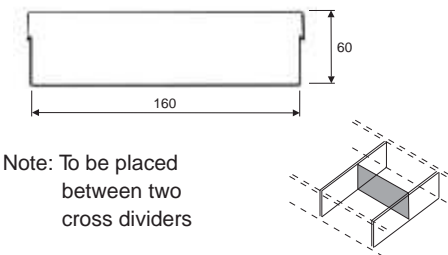
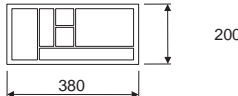
Schema	Description	Weight	Colour	Art. No.	Price
DRAWER DIVIDER - CROSS		Kg			EUR
	Drawer divider - cross	0,29	black RAL 9005	MDDT5	5,00
	Enabling classification of the drawer				
DRAWER DIVIDER - LONGITUDINAL					
 <p>Note: To be placed between two cross dividers</p>	Drawer divider longitudinal	0,1	black RAL 9005	MDDL5	1,00
	Enabling classification of the drawer - to be used only with the cross divider				
PLASTIC PEN TRAY					
	Plastic pen tray	0,2	black	PT-A	6,00
	To be inserted on the bottom of the drawer				

"UNIVERSAL"

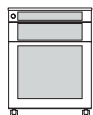
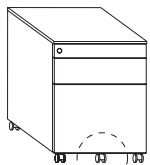

CENTRAL
LOCKING

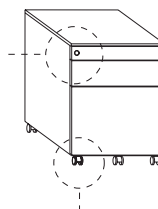

Baked
powder
coating

Metal
sheet

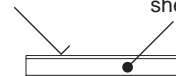

CARCASS COLOUR
ALUMINIUM RAL 9006

DRAWERS COLOUR
BLACK RAL 9005



FILE DRAWER
THIRD CASTOR
AS ANTITILT
DEVICE

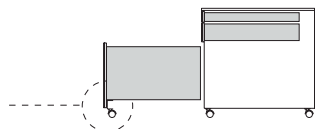

CASTORS
- ROTARY
- BLACK PLASTIC

"PROFESSIONAL"

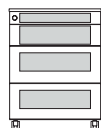
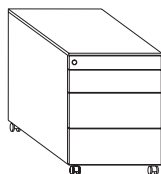

PEDESTALS PROFESSIONAL
EQUIPPED WITH THE ANTITILT
DEVICE



Antitilt device

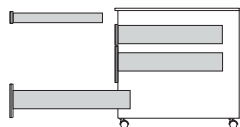

CERTIFICATE

PEDESTALS PROFESSIONAL ARE CERTIFIED "GEPÜRSCHEIT" "MAXIMUM LOAD 15 kg"

"UNIVERSAL CALL CENTER"

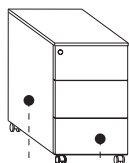

DRAWERS COLOUR
BLACK RAL 9005

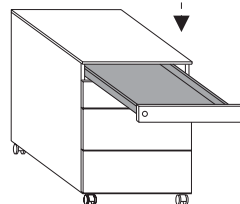
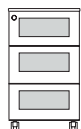

ACCESSORIES
INSERTED PLASTIC
PEN TRY FOR ALL
TYPES OF PEDESTAL

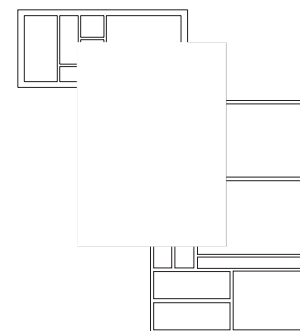

CARCASS AND FRONT
PANELS COLOUR
ALUMINIUM RAL 9006

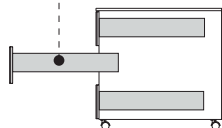

Dimensions are stated in millimetres. The products weight allowance is 5%.

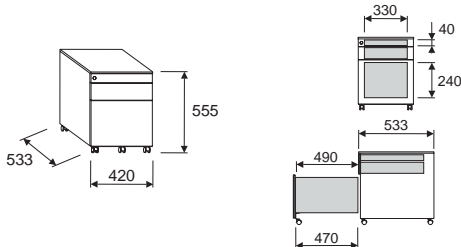
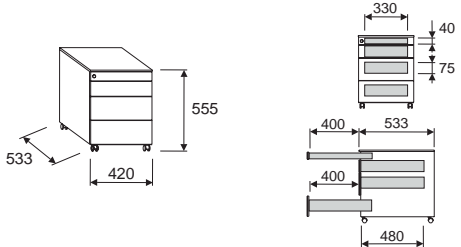
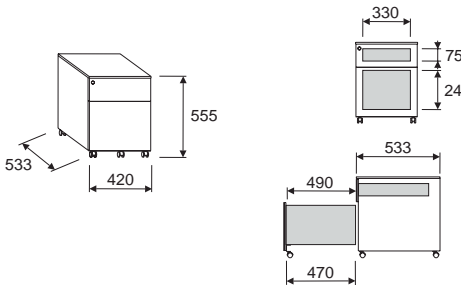
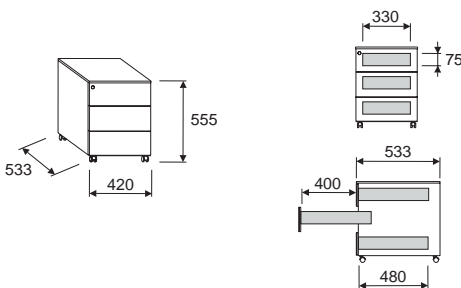
Schema	Description	Weight	Colour	Art. No.	Price
<p>"UNIVERSAL"</p> <p>MOBILE</p> 	DEPTH 533 mm	Kg			EUR
	Metal pedestal mobile with central locking	22,5	anthracite	MXM0582N	334,00
	- 1 pen drawer - 1 drawer - 1 file drawer	22,5	aluminium	MXM0582A	334,00
					
	Metal pedestal mobile with central locking	22,0	anthracite	MXM0583N	329,00
	- 1 pen drawer - 3 drawers	22,0	aluminium	MXM0583A	329,00
					
	Metal pedestal mobile with central locking	19,0	anthracite	MXM9582N	297,00
	- 1 drawer - 1 file drawer	19,0	aluminium	MXM9582A	297,00
					
	Metal pedestal mobile with central locking	19,0	anthracite	MXM9583N	294,00
	- 3 drawers	19,0	aluminium	MXM9583A	294,00

Dimensions are stated in millimetres. The products weight allowance is 5%.

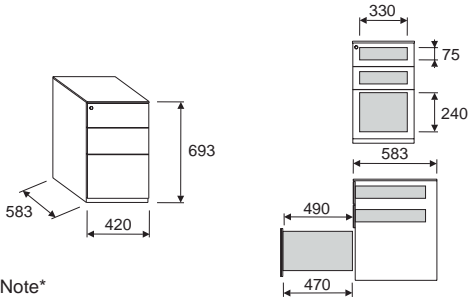
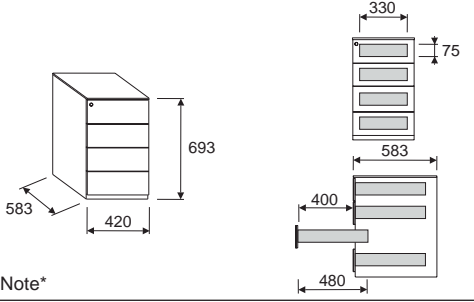
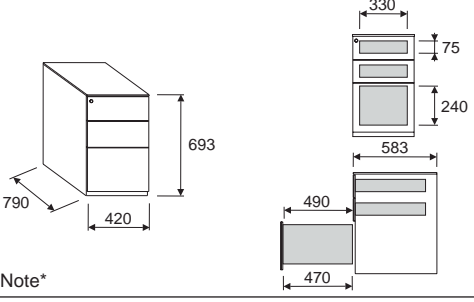
Schema	Description	Weight	Colour	Art. No.	Price
"UNIVERSAL" DESK-HEIGHT 	DEPTH 583 mm	Kg			EUR
	Desk height metal pedestal with central locking - 2 drawers - file drawer	36,5 36,5	anthracite aluminium	MXS9603N MXS9603A	426,00 426,00
	Desk height metal pedestal with central locking - 4 drawers	34,4 34,4	anthracite aluminium	MXS9604N MXS9604A	426,00 426,00
	DEPTH 790 mm				
	Desk height metal pedestal with central locking - 2 drawers - file drawer	43,0 43,0	anthracite aluminium	MXS9793N MXS9793A	456,00 456,00
<p>* - when using desk height pedestals together with BASIC and SIMPLE desks, the wooden top is highly recommended.</p>					

Dimensions are stated in millimetres. The products weight allowance is 5%.

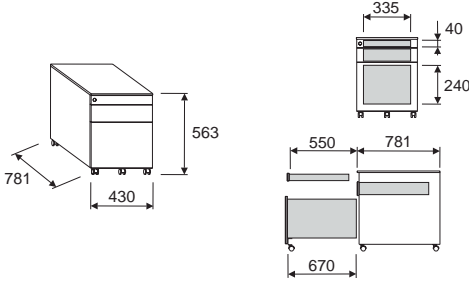
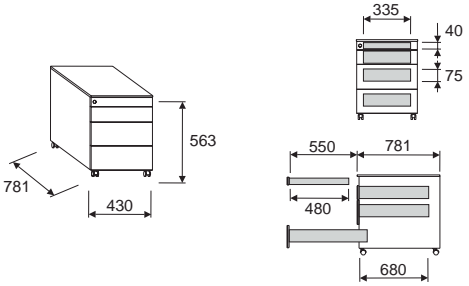
Schema	Description	Weight	Colour	Art. No.	Price
"PROFESSIONAL"	DEPTH 781 mm	Kg			EUR
	Metal pedestal mobile with central locking - pen drawer - 1 drawer - file drawer	41,0	aluminium	MXM0792A	566,00
	Metal pedestal mobile with central locking and antitilt device - pen drawer - 3 drawers	42,0	Aluminium	MXM0793A	549,00



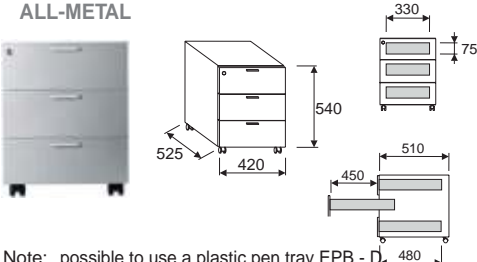
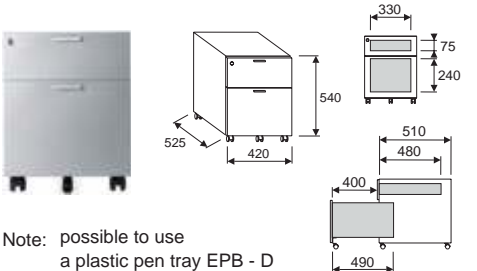
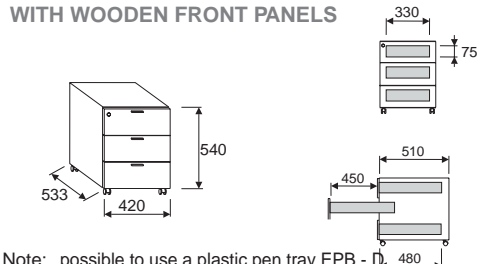
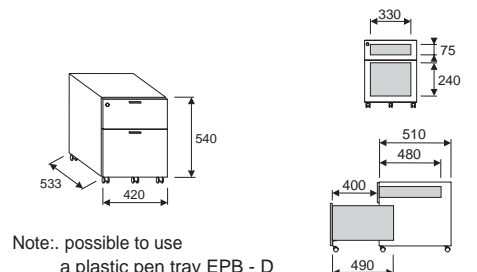

Dimensions are stated in millimetres. The products weight allowance is 5%.

Schema	Description	Weight	Colour	Art. No.	Price
<p>"UNIVERSAL CALL CENTER" MOBILE</p>	<p>DEPTH 533 mm</p> <p>Metal pedestal mobile with central locking 240 - 1 drawer - file drawer</p>	<p>Kg</p> <p>18,3</p>	<p>aluminium</p>	<p>MXM9532A</p>	<p>EUR</p> <p>297,00</p>
	<p>Metal pedestal mobile with central locking</p> <p>- 3 drawers</p>	<p>18,2</p>	<p>aluminium</p>	<p>MXM9533A</p>	<p>294,00</p>
<p>DESK-HEIGHT</p>	<p>DEPTH 583 mm</p> <p>Desk height metal pedestal with central locking</p> <p>- 2 drawers - file drawer</p>	<p>31,0</p>	<p>Aluminium</p>	<p>MXS9633A</p>	<p>426,00</p>
<p>Note*</p> <p>* - when using desk height pedestals together with BASIC and SIMPLE desks, the wooden top is highly recommended.</p>					

Dimensions are stated in millimetres. The product weight allowance is 5%.

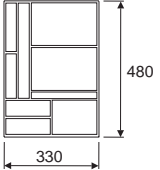
Schema	Description	Weight	Colour finishing	Art. No.	Price
<p>PEDESTALS" MXM" MOBILE</p> <p>ALL-METAL</p>  <p>Note: possible to use a plastic pen tray EPB - D</p>	<p>Metal pedestal mobile with central locking</p> <p>- 3 drawers</p>	Kg 22,0	aluminium RAL9006	MXM3A	EUR 168,00
 <p>Note: possible to use a plastic pen tray EPB - D</p>	<p>Metal pedestal mobile with central locking</p> <p>- drawer - file drawer</p>	22,0	aluminium RAL9006	MXM2A	169,00
<p>PEDESTALS" MXM" MOBILE</p> <p>WITH WOODEN FRONT PANELS</p>  <p>Note: possible to use a plastic pen tray EPB - D</p>	<p>Metal pedestal mobile with wooden front panels and central locking</p> <p>- 3 drawers</p>	23,0	aluminium RAL9006	MXMD3A	197,00
 <p>Note: possible to use a plastic pen tray EPB - D</p>	<p>Metal pedestal mobile with wooden front panels and central locking</p> <p>- drawer - file drawer</p>	23,0	aluminium RAL9006	MXMD2A	198,00

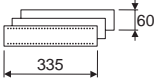
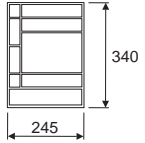
Dimensions are stated in millimetres. The products weight allowance is 5%.

Schema	Description	Weight	Package	Colour	Art. No.	Price
"UNIVERSAL"						
	Plastic pen tray It is inserted on the bottom of the drawer.	Kg 0,15	1 pcs	black	EPB-C	EUR 19,00
	Plastic pen tray It is inserted on the corpus of the drawer	0,1	1 pcs	black	EPB-D	9,00
 1 set = 3 pcs	Metal drawer divider - cross To be inserted into the corpus of the drawer	0,21	1 set	black	VS03	24,00
"PROFESSIONAL"						
 1 set = 3 pcs	Metal drawer dividers - cross To be inserted into the corpus of the drawer	0,2	1 set	black	VS03P	24,00
"UNIVERSAL CALL CENTER"						
	Plastic pen tray big To be inserted on the bottom of the drawer	0,1	1 pcs	black	EPB-E	13,00
	Crossbar To be put into file drawer	0,1	1 pcs		ASM341	12,00

The products weight allowance is \pm 5%.

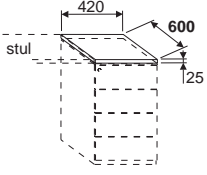
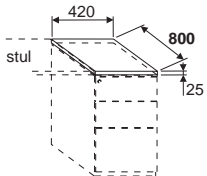
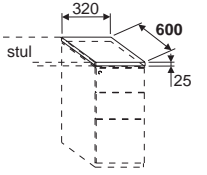
Schema	Description	Weight	Price	Art. No.	Price
"UNIVERSAL"		Kg	category		EUR
	Wooden top for desk height pedestal for desk depth 600 mm The wooden tops are offered in accordance with desks worktop	4,8	S	EB0426	19,00
		4,8	L	EBL0426	29,00
	Wooden top for desk height pedestal for desk depth 800 mm The wooden tops are offered in accordance with desks worktop	6,3	S	EB0428	24,00
		6,3	L	EBL0428	36,00
"UNIVERSAL CALL CENTER"					
	Wooden top for desk height pedestal for desk depth 600 mm The wooden tops are offered in accordance with desks worktop	3,6	S	EB0326	18,00
		3,6	L	EBL0326	26,00

Price category **S**: STANDARD colour finishings
 ADDITIONAL colour finishings

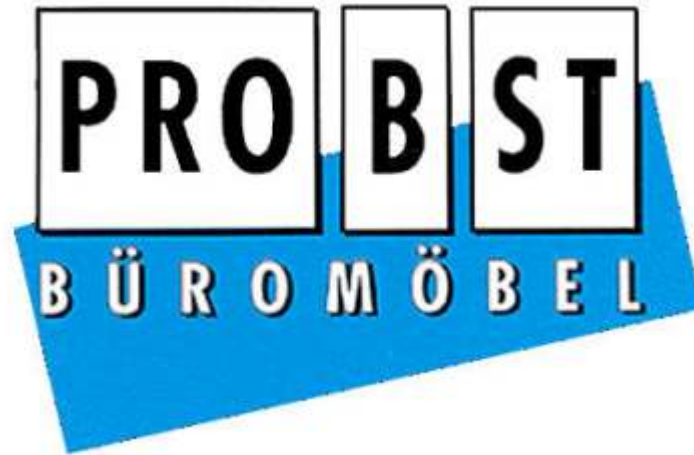

Probst Büromöbel GmbH
Maria-Probst-Str. 21-23
80939 München

Tel: 089/316677-0
Fax 316677-88

kontakt@probst-bueromoebel.de
probst-bueromoebel.de